



# **SATHYABAMA** **INSTITUTE OF SCIENCE AND TECHNOLOGY** **(DEEMED TO BE UNIVERSITY)**

*Accredited with 'A' Grade by NAAC | 12B Status by UGC | Approved by AICTE*

## *Sustainability Report* *2020 - 2021*



# Preamble

The term sustainable development and sustainability is gaining increased attention in recent years. It has become the most frequently discussed topic in the last few decades. The report by the Brundtland Commission developed the most widely used and popular definition of sustainable development as “development which meets the needs of current generations without compromising the ability of future generations to meet their own needs”. Every developmental initiative of Sathyabama Institute of Science and Technology focuses on sustainability. This Sustainability Report is an evidence of the Institution’s commitment towards achieving sustainable development.

The report is aimed at stakeholders who have an interest in our sustainability performance, including professional and academic staff, students, local communities and local businesses. It reveals the institutional approach and commitment to sustainability. This report focuses on our sustainability initiatives for the year 2020-2021.

## Message



**Dr. MARIAZEENA JOHNSON**

B.E., MBA., M.Phil., Ph.D.

**Chancellor**



**Dr. MARIE JOHNSON**

B.E., MBA., M.Phil., Ph.D.

**President**

We are very happy to publish the Institution's Sustainability Report, which provides a brief review of the work for the year 2020-2021.

Our Institution adheres to eco-friendly and sustainable development practices and advocate environmental protection initiatives like use of alternative and renewable energy, recycling of waste, reduction of plastic usage, reduction in carbon emissions, reduction of food wastage and adoption of organic farming. The staff and students of our institution have understood their role in building a sustainable community and actively participate in all our environmental protection initiatives.

Sustainability is gaining increased attention in recent years. Traditionally, Higher Educational Institutions are expected to play a major role in educating the youth and nurturing future leaders and citizens. But now the role of Higher Educational Institutions is drastically changing and moving towards addressing the societal challenges. Since the evolution of the Millennium Development Goals and the Sustainable Development goals, sustainable growth has become a major concern for administrators and leaders. Sathyabama strives to acknowledge and adopt the concept of sustainability in its academic, research and developmental pursuits.

We are very happy that we are able to make significant progress toward the Sustainable Development Goals proposed by Agenda 2030 that aims to protect people and the planet.

## Foreword

Sathyabama is known for its commitment to societal development, apart from its academic and research excellence. It is bestowed with state of the art infrastructure and world class research facilities and recognized as one of the top higher educational institutions both at national and international level.

Sustainable development emphasizes on economic progress with due recognition on environmental and societal aspects. Any advancement is considered to be real only if it is not made at the cost of the environment. It is high time that we all stop our unsustainable practices and start getting involved in efforts to preserving natural resources. Our Institution is one of the fore runners in adopting innovative practices to achieve sustainable development.

Academic and Research initiatives of the Institution are focused on the achievement of the sustainable development goals like eradicating poverty and hunger, developing good health and well-being, creating access to clean and affordable energy, combating climate change, reducing economic inequalities, promoting gender equality and developing sustainable community. Our Institution's curriculum is designed in such a way that sustainable development is the core of it. We have dedicated Research Centres like Centre for Energy Research, Centre for Climate Change Studies, Centre for waste Management, Centre for Ocean Research and Centre for Drug Discovery and Development that are working towards the achievement of United Nation's Sustainable Development Goals -Agenda 2030.

We are happy to publish this report that publicizes our Institution's efforts to build a safe, prosperous, resilient and sustainable community.

**Dr. T. SASIPRABA, M.E., Ph.D.**  
**VICE CHANCELLOR**

## **Editorial Team:**

- Dr. T. Sasipraba, **Vice Chancellor**
- Dr. E. Logashanmugam, **Pro Vice Chancellor**
- Dr. S.S.Rau, **Registrar**
- Dr. S. Igni Sabasti Prabu, **Controller of Examinations**
- Dr. B. Sheela Rani, **Director – Research**
- Dr. G. Sundari, **Director - Administration**
- Dr P Kuppusami, **Senior Scientist, Centre for NanoScience and Nanotechnology**
- Dr S Prakash, **Scientist, Centre for Climate Change Studies**
- Dr. Amit Kumar, **Scientist, Centre for Climate Change Studies**
- Dr Thanga Suja, **Scientist, Centre for Climate Change Studies**
- Dr S S Dawn, **Scientist, Centre for Waste Management**
- Dr Inbakandan, **Scientist, Centre for Ocean research**
- Dr Nagamani, **Scientist, Centre for Remote sensing and Geo Informatics**
- Dr Krupakar Parthasarathy, **Scientist, Centre for Drug Discovery**
- Dr Devayani Gangopadhyay, **Dean, School of Building and Environment**
- Dr Dilshad Sheik, **Dean, School of Law**
- Dr. A.Chitra Devi, **Associate Professor, Centre for Academic Partnership & International Relations**
- Dr. Preethi Sheshadri, **Associate Professor, Centre for Academic Partnership & International Relations**
- Ms.V Lakshmi Priya, **Research Assistant, Centre for Academic Partnership & International Relations**

<b>S. NO.</b>	<b>Contents</b>	<b>PAGE NO.</b>
	A About SATHYABAMA	1
	B Rankings and Ratings	1
	C Sathyabama’s Sustainability Approach And Perspective	3
	D Research at Sathyabama	4
	E Research focusing on Sustainable Development Goals	5
	F Society and Community	7
	G Sustainable Development Goals	12
	<b>1 SDG 1- NO POVERTY</b>	<b>13</b>
1.1	Admission of students belonging to lower income group with full scholarships	13
1.2	Relationship with Adopted Schools And Villages	14
1.3	Summer Camp and “My Saturday University”	15
1.4	Goals and Achievements	15
1.5	Adoption of villages	16
	<b>2 SDG 02 ZERO HUNGER</b>	<b>18</b>
2.1	Research Contribution	18
2.2	Training Programmes	19
2.3	Outreach Programmes	19
2.4	Food Distribution during Natural Disasters:	20
2.5	Women Empowerment and Eradication of Hunger	20

<b>S. NO.</b>	<b>Contents</b>	<b>PAGE NO.</b>
<b>3</b>	<b>SDG 03 GOOD HEALTH AND WELL-BEING</b>	22
3.1	Collaborations to improve health and well being	23
3.2	Outreach Programme and projects	25
3.3	Sharing Sports facility for Local community	27
3.4	Information and healthcare services for sexual and Reproductive Healthcare	27
3.5	Access to mental Health support to student and staff	28
3.6	University Smoke Free Policy	29
3.7	Publications	29
<b>4</b>	<b>QUALITY EDUCATION</b>	36
4.1	Adoption of Schools	37
4.2	Adopted Schools and their requirements satisfied for the period 2019-2020	39
4.3	Skill Development Centre	40
4.4	Centre for Professional and Career Advancement	41
4.5	Guidance for Higher Studies	42
4.6	Jeppiaar IAS Academy	42
<b>5</b>	<b>GENDER EQUALITY</b>	43
5.1	Aims and Goals	46
5.2	Seminars and Workshops	47
5.3	Gender Ratio among Scholarship Students	48
<b>6</b>	<b>CLEAN WATER AND SANITATION</b>	49
6.1	Ensure availability and sustainable management of water and sanitation for all	49

<b>S. NO.</b>	<b>Contents</b>	<b>PAGE NO.</b>
6.2	Prominent initiative taken by the Institution –Establishment of Sewage Treatment Plant	50
6.3	Research publications	51
6.4	Innovation which are strongly supporting SDG 6	53
6.5	Patent Filed during the Year 2020-2021 related to SDG 6	55
	<b>7 AFFORDABLE CLEAN ENERGY</b>	<b>52</b>
7.1	Clean, Green and Renewable Energy	56
7.2	Clean Energy Sources and Potentials	57
7.3	India’s Performance in Clean Energy	59
7.4	Status on the Clean Energy Programme at our Institute	60
7.5	Collaborations established and continued	63
	<b>8 DECENT WORK AND ECONOMIC GROWTH</b>	<b>66</b>
	Promote sustained, inclusive and sustainable economic growth, full and productive employment and decent work for all	
8.1		66
8.2	Graduate Employability	67
8.3	Study Programmes	67
8.4	Informal Student employment initiatives	68
8.5	Integration of persons with disabilities	69
8.6	Educational equity and community Development	69
8.7	Strategy for Economic Empowerment	69
	<b>9 INDUSTRY INNOVATION AND INFRASTRUCTURE</b>	<b>71</b>
	Centre of Excellence for Collaborative Product Design and Development (CPDD)	
9.1		72



<b>S. NO.</b>	<b>Contents</b>	<b>PAGE NO.</b>
9.2	Infrastructures for Innovations	74
9.3	3 Industry Institute Interaction Cell	76
9.4	Executive Development Program	77
10	<b>REDUCED INEQUALITIES</b>	78
10.1	Introduction:	78
10.2	Goals	79
10.3	Scholarship for Disabled Students	80
10.4	Scholarship for Meritorious Students from Socially and Financially Poor Background.	81
10.5	Arrangement With Global Network Equality :(Prisoners Welfare)	81
10.6	Facilities Offered	82
10.7	Support for Excellence	82
10.8	Grievance Cell	82
10.9	Placements for the Disabled	83
11	<b>SUSTAINABLE CITIES AND COMMUNITIES</b>	84
11.1	Leading by example , we provide a sustainable campus	84
11.2	Contribution to Sustainable development of city	85
11.3	Centre of Excellence in Urban Climate and Built environment	86
11.4	Capacity building programs	86
11.5	Sustainability as an integral part of Academic learning	87

<b>S. NO.</b>	<b>Contents</b>	<b>PAGE NO.</b>
<b>12</b>	<b>RESPONSIBLE CONSUMPTION AND PRODUCTION</b>	90
	Objective 1: Decoupling environmental degradation from	
12.1	economic growth.	90
12.2	Abstract of the Invention	93
12.3	Abstract of the Invention	94
12.4	Abstract of the Invention	95
12.5	Societal outreach program	103
<b>13</b>	<b>CLIMATE ACTION</b>	100
13.1	Who we are	100
13.2	Research Areas	101
13.3	Coastal Ecosystem Conservation	107
13.4	Teaching and Learning	109
13.5	Sathyabama Marine Research Station	120
<b>14</b>	<b>LIFE BELOW WATER</b>	111
14.1	Reduce Marine Pollution	112
14.2	Protect and Restore Ecosystems	116
14.3	Reduce Ocean Acidification	118
14.4	Sustainable Fishing	122
14.5	Conserve Coastal and Marine Areas	124
14.6	End Subsidies Contributing to Overfishing	131
14.7	Increase Scientific Knowledge, Research and Technology for Ocean Health	137

<b>S. NO.</b>	<b>Contents</b>	<b>PAGE NO.</b>
15	<b>LIFE ON LAND</b>	144
15.1	Centre for Climate Change Studies (CCCS)	144
15.2	Centre for Remote Sensing and Geoinformatics	145
16	<b>PEACE, JUSTICE AND STRONG INSTITUTIONS</b>	148
16.1	Social justice at the heart of promoting health and wellbeing	152
17	<b>PARTNERSHIPS FOR THE GOALS</b>	154
17.1	Research Collaborators at National level	154
17.2	Internationalization at Sathyabama	155
17.3	Centre for Academic Partnership and International Relations	155
17.4	International Alliances and Collaboration	156
17.5	Erasmus Plus-International Credit Mobility Programme	163
17.6	Mevlana Exchange Programme	164
17.7	Visiting International Professors	165
17.8	Indonesian delegation visit to our institution	166
17.9	A Glimse Of Mou Signing With International Universities	166
17.10	International Research Collaborations	167
17.11	Post-Doctoral Fellowships/Recognitions by Faculty and Students	171
17.12	Faculty Exchange/Research Programmes 2019--2020	174
17.13	Outcome of Collaborative Research	178

## **A ABOUT SATHYABAMA**

Sathyabama Institute of Science and Technology is one of India's premier Academic and Research universities that offers multi-disciplinary academic programmes in various fields of Engineering, Science, Technology, law, Dental Science, Pharmacy, Nursing, and Management. It is established under Sec.3 of UGC Act, 1956 and is been Accredited with 'A' Grade by the National Accreditation and Assessment council. The Institution persistently seeks and adopts innovative methods to improve the quality of higher education and is responsive to the changes taking place in the field of education on a global scale. This glorious Institution is functioning under the dynamic leadership of Dr. Mariazeena Johnson, Chancellor and Dr. Marie Johnson, President.

## **B. Rankings and Ratings**

Sathyabama Institute of Science and Technology has been recognized as an Institution involved in high quality teaching and research in diverse fields. It has got high visibility and is placed among the top ranking Universities at National and International level. NIRF - National Institutional Ranking Framework, MHRD has ranked Sathyabama in the 40<sup>th</sup> position in the University category, and this is the sixth consecutive year it has been placed amongst the Top 50 Institutions in India. On behalf of the Institution I sincerely thank all the stakeholders for their contribution in our pursuit for excellence.

We are proud to share with you that our Institution is ranked among the Top 5 Private Institutions in India for Innovation by Atal Ranking of Institutions on Innovation achievements (ARIIA).

Sathyabama institute of Science and Technology has been ranked in 301-350 position by QS Asia University Rankings 2021.

The Institution is placed in very good positions in Times Higher Education Impact Rankings 2021, which ranks the Universities across the world based on their contribution to the UN's Sustainable Development Goals. Sathyabama has secured notable ranks with respect to all the

four Sustainable Development Goals (SDG- 1,10,13,17) for which it has applied. Recognising the significant contribution of the Institution towards reducing inequalities (SDG 10), climate action (SDG 13) and Partnership for goals (SDG 17), it has been ranked in 201 – 300 position among the Universities worldwide. The Institution has been ranked in 301-400 position for SDG01 – No Poverty, recognising its contribution towards eradicating poverty. Sathyabama's overall position is 601-800 among the world Universities according to the Times Higher Education Impact Rankings, 2021.

Sathyabama Institute of Science and Technology has been awarded with `E-LEAD (E-Learning Excellence for Academic Digitisation) Certification by the QS I-Gauge, the Indian arm of the QS, the global rankings and ratings agency. The Institution is assessed on various parameters like involvement of Teachers and students, efficient usage of IT infrastructure, adequate IT support systems and IT policy and certified for its preparedness to conduct Teaching& Learning and Student Engagement activities online.

Times Higher Education has ranked Sathyabama among the top Institutions worldwide. It is also been placed in good positions in the Times Higher Education's Subject Ranking for Engineering and Physical Sciences, Emerging Economies Universities Ranking and Young Universities Ranking, for the year 2021.

India Today has ranked Sathyabama in the 4th position among the Best Private Universities in Tamilnadu for the year 2021

India Today has ranked the Institution in the 22nd place among the Top Private Engineering Colleges as well as Top Private Universities in India for the year 2021.

India Today has ranked the Institution in the 20th place among the India's Best Architecture Colleges 2021.

Outlook Magazine has ranked the Institution in the 19th place among the India's Best Colleges offering Architecture Programme for the year 2021.

Sathyabama is Ranked No. 34 among the Top Multi-Disciplinary Universities in India, Ranked No. 14 among the Top Multi-Disciplinary Universities in South Zone,

Ranked No. 3 among the Top Non-Government (Private & Deemed) Multi-Disciplinary Universities - South Zone by THE WEEK Survey, 2021

The Institution has got three major programmes accredited by the National board of Accreditation, including B.E.-Biomedical Engineering, B.E.- Chemical Engineering and B.Tech Information Technology and Aeronautical Engineering in addition to the 3 programmes accredited in the previous year.

Sathyabama has been conferred with 12B status by University Grants Commission which has made the Institution eligible to receive assistance from Central Government to undertake more sponsored research projects.

### **Schools/Department/Courses**

There are 8 Schools namely,

- School of Computing,
- School of Electrical and Electronics,
- School of Mechanical Engineering,
- School of Bio and Chemical Engineering,
- School of Building and Environment,
- School of Management Studies,
- School of Science and Humanities
- School of Pharmacy
- School of Nursing
- School of Dental Science
- School of Law

Sathyabama faculties have reached milestones in publishing high impact factor journals. The Institution has around 16,000 Research publications Indexed in Scopus and Web of Science databases to its credit and the H -index of the Institution is 73. More than 300 Joint Publications are made as the outcome of the joint research with International Research Organizations and Universities. Sathyabama's commitment to research can also be well understood by the number of patents granted for the innovative products and designs. The Institution has 90 patents to its credit for the year 2020-21 and waiting for the grant of more patents as it has filed for 200 more patents.

## C. SATHYABAMA'S SUSTAINABILITY APPROACH AND PERSPECTIVE

### Teaching and Learning

Sustainability forms the core of teaching and the notion of sustainable development is instilled in the students. Students are educated about the sustainability issues and a sense of responsibility is created.

Sathyabama is committed to providing a quality education to students to develop them as responsible citizens who are concerned about their environment. We design our curriculum with adequate emphasis on environmental education. Subjects relating to sustainable development are included in the curriculum of all branches of studies, ensuring that all of our students are groomed as professionals who follow sustainability principles in their professional life.

### Sustainability in the curriculum

To have sustainability principle inbuilt in the curriculum the following subjects are included in the curriculum of the University.

- Green computing for Computer science students
- Energy Engineering
- Environmental impact assessment
- Environment pollution control
- Disaster management
- Water resources engineering
- Air and noise pollution
- Ground water engineering
- Solid waste management
- Environmental planning and design
- Wind and solar energy
- Health informatics
- Environmental science and engineering
- Environmental biotechnology
- Biosafety, bioethics and IPR
- Irrigation engineering
- Energy and environmental management
- Sustainable architecture

## **D. Research at Sathyabama**

Sathyabama Institute of Science and Technology is one of the Academic Institutions that gives more emphasis to research as it is aware of the significance of research for sustainable growth and development. To address the global challenges with respect to social, economic and environmental issues, the Institution is involved in breakthrough research and innovation in the thrust areas of Science and Technology.

Academic research is considered to be very important to offer solutions to the problems encountered by the Industries. Having understood the need for sharing knowledge between Industries and Universities, Sathyabama collaboratively work with many of the industries and the fruit of the synergistic effort are enjoyed by the Institution, Industry and Society.

Quality education and research are the twin objectives of the Institution that goes hand in hand. It has made huge investments in building research infrastructure, which is indication of its commitment to research. Sathyabama has 2 research parks namely International Research Centre and Col. Dr.Jeppiaar Research Park to translate innovations into product and technology.

These 2 research parks houses research centres carrying out research on almost all the major areas of science and Technology. These centres include

- Centre for Nanoscience and Nanotechnology
- Centre for Energy Research
- Centre for Ocean Research
- Centre for Space Technology
- The Centre for Bioresource Research and Development
- Centre for Laboratory Animal Research
- Centre for Climate Change Studies
- Centre for Drug discovery and development
- Centre for Earth and Atmosphere Science
- Centre for Remote Sensing and Geoinformatics
- Centre for Robotics and Automation
- Centre for Quality Assurance and Non-Destructive Evaluation
- Centre for Waste Management



## **E. Research focusing on Sustainable Development Goals**

Research at Sathyabama addresses the Sustainable Development Goals of Agenda 2030, which requires the participation of individuals, institutions, countries and Governments in creating a better world free from poverty, hunger, health issues, inequalities, and providing access to quality education, access to clean water and sanitation, access to affordable and clean energy.

- Research relating to the Sustainable Development Goal –SDG 7, addressing the issue of Affordable and Clean Energy is undertaken by the Centre of Excellence in Energy Research funded by MHRD, working towards finding sustainable solutions to the need for energy. This Centre is focussing on research in energy storage and sustainable energy conversion materials, to address the challenges in the energy technologies that strive to fulfil the needs of increasing demand for energy, without affecting environment and due concern for reducing the carbon print.
- Centre for Nanoscience and Nanotechnology focuses on research relating to nanomaterials, nanotechnology, nanocomposites, nanoelectronics, nanofabrication to develop clean, affordable, and renewable energy sources or develop products that consumes less energy and cause less environment pollution.
- Centre for Climate Change Studies focuses on research addressing the most important Sustainable Development Goal –SDG-13 on Climate Change along with SDG 14-Life below Water. This Centre is involved in several key projects that assess the impact of global climate change on marine organisms and ecosystems like Coral reefs, Sea grass meadows, Intertidal zones, Mangrove ecosystem etc. through long term monitoring of selected coastal sites.
- Research in Mariculture, Marine Technology and Engineering, Marine Ecology, Marine Nanotechnology, Marine Biotechnology, and Marine Education is the focus of the Centre for Ocean Research which is working towards SDG 14
- Research in the area of waste management, which works on the 3 R concepts-Reduce, Reuse and Recycle is undertaken by the Centre for Waste management at Sathyabama. This Centre, which is working towards the achievement of SDG 12-Responsible

consumption and production and SDG13, has come out with a biodiesel from waste cooking oil and bio fertilizers from food waste.

- Research to discover novel drugs to fight against life threatening infectious diseases including tuberculosis(TB), Acquired Immuno Deficiency syndrome (AIDS), Dengue and non-infectious diseases including cancer, diabetes etc., which is addressing the SDG-3 Good Health and Well-being is the focus of Centre for Drug Discovery and Development.
- Research facilitating resilience and adaptive capacity to climate related hazards, disaster preparedness against flood related disasters through remote sensing and geoinformatics, addressing SDG 13. Centre for Remote-sensing and Geo-informatics is involved in the research relating to forecasting of weather and climate to meet the exigencies of the threats due to natural calamities and manmade deterioration of the environment.

## **MARINE RESEARCH STATION**

Apart from the Research Centres within the campus, Sathyabama Institute of Science and Technology has established a new Marine Research Station at Rameswaram to encourage research on cutting-edge marine ecology and climate change. The research station would be helpful to “conduct and organize studies related to the coastal and marine biodiversity conservation, and to understand the impact of anthropogenic stressors on the marine ecosystems and associated organisms in the Gulf of Mannar and Palk Bay region. This initiative is successful with the support of the state forest departments, state and central government universities and institutions, marine police, fishery department officials, NGO’s and coastal communities and create awareness among youths towards marine conservation.

## **Publications and Patents**

The Institution has around 16,000 Research publications Indexed in Scopus and Web of Science databases to its credit and the H –index of the Institution is 73. More than 300 Joint Publications are made as the outcome of the joint research with International Research Organizations and Universities. Sathyabama’s commitment to research can also be well understood by the number

of patents granted for the innovative products and designs. The Institution has 90 patents to its credit and waiting for the grant of more patents as it has filed for 200 more patents.

## **F. SOCIETY AND COMMUNITY**

### **F.1 Sustainable Community**

Sathyabama Institute of Science and Technology is involved in community development initiatives that contribute positively to the development of sustainable community. It is playing a vital role in developing a sustainable community

- where the needs of everyone in the community are met and people feel safe, healthy and happy and the prosperity jointly enjoyed
- Where the needs are met while ensuring that adequate resources are available for future generations.
- where the environment is appreciated, protected and damage to the environment is minimised
- Where the employment opportunities are growing and working lives are more rewarding

It is working to achieve the following goals

- Clean air and water and nutritious food for everyone
- Protection of ecosystems and biological diversity
- Conservation of water, land, energy, reduction, reuse and recycling of waste.

To pursue these goals, the Institution:

- Use appropriate technology to minimize emissions and pollution
- Use of renewable energy
- Advocates green concepts like organic farming
- Minimize waste
- Avoid usage of plastics
- Advocate Plantation drive

- Advocates mass transportation
- Advocates the usage of bio-fuel and bio-fertilizers
- Promotes eco-conscious and eco-friendly initiatives

## **F.2 Participation in government Initiatives**

The Faculty members and the Research Scientists of Sathyabama are actively participating in Unnat Bharath Abhiyan, a Government of India's initiative to develop villages by providing technical solutions to their problems. Sathyabama has adopted 5 villages and helped them in solving some of their issues by providing technical solutions, which are purely the outcomes of the research.

## **F.3 Environment Consciousness Initiatives of the Institution for promoting sustainable development**

### **F. 4 Carbon Neutrality**

Only the University buses are allowed inside the campus, which is the only mass transit system. No private vehicles of staff or students are allowed inside the campus, and hence the pollution is almost nil. More trees are scheduled to be planted in future through eco club and a separate land space is allotted to encourage farming.

### **F.5 Reduction of carbon footprint**

At Sathyabama, all the possible actions that produce greenhouse gases are identified and monitored. Efforts are taken to reduce the usage of fossil fuel. One notable initiative is usage of bio-fuel for running some of the Institution's buses. In fact, the bio-fuel is a research outcome of our Centre for Waste Management that adopts innovative technologies for developing cleaner and greener environment. Bio-fuel/bio-diesel is produced from the waste cooking oil generated from the institution's huge cooking facility. The vegetable waste generated after cooking is also effectively converted into bio fertilizer.

This Centre conducts several programmes to students and public to create awareness about waste segregation and management.

#### **F.6 Water consumption**

Students and staff of the Institution are instructed to use minimum water and avoid wastage of water. Water saving taps are fitted in rest rooms, wash basins and in student hostels.

#### **F.7 Recycling of waste water**

The Institution has a Sewage Treatment Plant that recycles the waste water. The contaminants are treated and reduced to safe level according to the standards of environment agency and removed. The purified water is used for flushing in toilets and watering the plants in the garden.

<https://www.sathyabama.ac.in/campus-life/stp-plant>

#### **F.8 Transportation**

Sathyabama advocates mass transportation to reduce carbon emissions and carbon foot print in the environment. The Institution has around 150 buses used for the commutation of staff and students to and from the Institution. It is compulsory for the students to use the Institution run buses. This environmental conscious initiative not only reduces the cost of transportation, but contributes to the reduction in air pollution to a very large extent.

<https://www.sathyabama.ac.in/campus-life/transport-facility>

#### **F.9 Reduction of food waste**

The Institution has very big cooking facility that prepares food for around 12000 people. Effective measures are taken to minimize and avoid food waste. One Unique feature of Sathyabama is, anyone visiting the Institution can have food at the Institution's mess free of cost. Moreover as a philanthropic act, the Institution provides food to hundreds of children, old people and destitute women living in the nearby community. This is one small CSR effort of the Institution to feed the hungry mouths.

### **F.10 Plastic Reduction**

Usage of plastic is minimized in the campus. Drinking water coolers are installed at accessible places for students and staff. Usage of polythene covers, plastic water bottles and plastic cups are avoided. Reusable plastics are responsibly used and recycled.

### **F.11 Supplier evaluation**

Responsible consumption-behaviour is promoted in the Institution. An item will be purchased only after ruling out the possibility of repair and reuse. Purchasing will be approved from a particular supplier, producer, manufacturer and distributor only if the green standards are satisfied by them.

### **F.12 Training for staff and students**

Staff members and students of the Institution are given adequate training to learn and follow sustainable practices. No initiative of the Institution can be successfully implemented without the active participation of the staff.

### **F. 13 Food wastage**

University is taking measurable initiatives towards reduction of the food and energy wastage in the campus. Planning and monitoring committee suggestions of the University are helping time and again for waste management; effective power supply management is one such example. Bio degradable and non-bio degradable wastes are segregated separately in the campus and bio degradable wastes are used as food for cattle and used as manure for the plants and trees. Non bio degradable wastes are disposed through the waste disposal adopted through Chennai Metropolitan garbage cleaning methods. Paperless University will be the game changer towards boosting up objective of the environmental friendly campus.

## G SUSTAINABLE DEVELOPMENT GOALS

In 2015, 193 Nations agreed with the United Nation that they can change the world for the better by eradicating poverty and hunger, promoting good health and quality education, promoting gender equality, promoting access to clean water and clean energy, taking actions to combat climate change, protecting life below water and life on land, Promoting peaceful and inclusive societies for sustainable development and strengthening the means of implementation and development through global partnerships for sustainable development.



## SATHYABAMA'S CONTRIBUTION TOWARDS SUSTAINABLE DEVELOPMENT GOALS

Sathyabama Institute of Science and Technology support the implementation of every SDG, through learning and teaching, research and organizational governance.

### SDG 1- NO POVERTY



#### 1.1 Admission of students belonging to lower income group with full scholarships

Sathyabama aims at creating a society where all are employed and poverty is eradicated. Sathyabama believes that education is an instrument to remove poverty. Sathyabama has a reputation as one of the big universities in India. It is a prestigious institute and the Placement cell of Sathyabama have never fallen short of their goals in placing the students who have passed out. A strong Alumni is one of our prides. Every year, we offer admissions to around 500 students, from very poor background, in various streams in our university including, Engineering, Arts, Science, Law and Management. While it is very difficult to select the actual needy, we have tied up with NGO's like Agar am, Maryam, Ability, etc., who help us find the truly deserving students from very low economic background.

The Institution not only provides the fee waiver to these students, but also provides food and on campus accommodation free of cost to enable them to complete their studies. Performance of the students receiving scholarships, are monitored and the students who need special attention are given the additional support. They are given all the support needed to develop them into qualified graduates with employability skills. These students earn their degree and get placed in prestigious organizations, taking their family and their society up as they grow.





Anbu Scholarship Students

## **1.2 RELATIONSHIP WITH ADOPTED SCHOOLS AND VILLAGES**

Sathyabama has adopted 21 government schools and 5 villages in the neighborhood. These schools have children from very poor background and some of the schools lack basic facilities. Sathyabama has always provided all that those schools need, starting with Laptops, to Speakers, OHP's, CCTV, Television sets, printers. Sathyabama has also played an important role in inspiring the students.

When these students visit the college, be it for their summer camp, or for the “ My Saturday academy”, where they visit the university every third Saturday, just to get to see the laboratories, use the computer lab, and get a feel of how college would be. This is just to inspire them to study well and the assurance that if they get good marks in their board exams, they can study free of cost in this prestigious university, where even hostel and food facilities are offered free. It is a dream come true for many and hence they are inspired to study well and pull their families out of poverty.

### **1.3 SUMMER CAMP AND “MY SATURDAY UNIVERSITY”**

The Adopted schools have summer camps for at least 5 days every summer and food snacks and transportation is provided to all the kids who attend. These kids also come to the University campus, for another activity called, “My Saturday University”, which gives them a glimpse of University life and they are also picked up from their respective schools and breakfast lunch and snacks are given. Summer camp is also held for the kids of the work force, teaching and non-teaching staff, every year and they are also given special food and lots and lots of goodies at the end of the camp. The Women Empowerment Bureau always arranges many training programs and all the women who come to the University campus are always given good food.

In fact, Sathyabama has a reputation for the quality and the taste of the food served in the campus.



### **1.4 GOALS AND ACHIEVEMENTS**

The goal of Sathyabama’s CSR arm was to adopt at least 20 government schools and 10 villages. We have till date adopted 21 government schools and 5 villages. Living in a hunger and poverty free society has been Sathyabama’s dream. Our founder Chairman Dr. Col Jeppiaar, had made a mission of feeding anyone who visits the college and this tradition has been carried on till date.

### 1.5 Adoption of villages

Sathyabama Institute of Science and Technology has also adopted 5 villages in the neighbourhood. Realising that teaching a person to fish is better than to feed him, Women empowerment bureau of the Institution conducts several training programmes and vocational courses for women of these villages to financially empower them. It also works with some of the NGOs for the upliftment of the downtrodden by providing them training in a vocation and facilitating income generation. More than 1000 women are trained in mushroom cultivation, sea weed cultivation, ornamental fish culturing, solar lamp making, baking, tailoring, sanitary napkin making, house-keeping, beauty and wellness etc.



Training Programmes to women



Training on Baking

The prestigious “Holiday Inn” has trained 50 women in housekeeping and had also assured employment for the women in their hotels, if they find them good during training. Three women were placed for employment and that income has helped the families immensely.



Life Skill Training for women's from Perumbakkam

## **SDG 2 - ZERO HUNGER**



Hunger and malnutrition impedes the human progress and pose a major challenge for achieving sustainable development. Research reveals nearly 800 million people live in extreme poverty across the world. To move towards a world where there is no poverty, the world community should jointly take efforts to improve the food system, practice sustainable agriculture, enhance socio-economic status of the people living in poverty, and develop rural economies.

Climate change is the main reason for the decline in food production and the consequent hunger and food security issues faced by the global community. In India food security is a major problem to be addressed in priority over other problems as India failed to achieve the Millennium Development Goal-1 with respect to eradication of poverty and hunger. The problems associated with Climate change, such as declining fertility of land, increasing water scarcity are to be addressed properly in order to increase the agriculture productivity. To end hunger and all forms of malnutrition and to ensure access to food to everyone, by 2030, requires the support of Educational Institutions. We believe higher educational Institutions like us can contribute to eradicate the problem of hunger and malnutrition through innovative research.

### **2.1 Research Contribution**

At Sathyabama, research on effective agricultural practices, organic farming and pest control are undertaken. The Centre for climate change studies is involved in research addressing the issues like maintenance of ecosystems and avoiding degradation of eco-systems, adaptation to climate change, water scarcity, ground water resources and irrigation. Centre for Remote Sensing and

Geoinformatics is also involved in research that addresses the change in rainfall pattern, anthropogenic disaster monitoring and so on.

## **2.2 Training Programmes**

The Institution conduct

- Training programmes to students and outsiders in order to develop awareness on these issues and encourage responsible behaviour to combat human caused climate change and promote sustainable way of life.
- Training programmes to farmers on sustainable and resilient agricultural practices.
- Awareness programmes on food wastage and ways to avoid food wastage.

## **2.3 Outreach Programmes**

Sathyabama has always had a social consciousness about the society we are in. The needy and poor are always helped, and many projects to empower them with employment has always been the mission. The students also do a lot of outreach activities in the schools and villages that we have adopted.

The Institution sponsors food to old age homes, homes for destitute women and Children's home in the nearby community as a small step towards eradication of hunger.

Sathyabama's CSR arm has arrangement to donate food to the following orphanages and Homes. Everyday lunch is sent to 120 persons to Little Hearts orphanage in Panaiyur. On the first Saturday of every month 1200 poor people are fed in little mount church and every alternate Tuesdays. 1200 people are fed in the Palavakkam church. About 100 orphan kids in Pudhupakkam get lunch and breakfast from Sathyabama. Other than these, snacks will be sent to some of the students of adopted schools when they stay late for Special classes for their board exams. Christmas is a season of celebration and Sathyabama never fails to extend its arm to the orphanages and Home for the aged, where special food and delicacies are served. Christmas Baskets are sent out in the hope to bring cheer and happiness.

## 2.4 Food Distribution during Natural Disasters:

Other than giving food to orphanages and Homes, Sathyabama has never failed to rise to any occasion, during natural calamities in Chennai. The huge kitchen in Sathyabama that feeds more than 5000 people every day, three times a day, effortlessly starts cooking for the masses during any natural calamity. The students also volunteer and their active participation has always been Sathyabama's strength. The food that is cooked and packed by the efficient kitchen gets distributed effortlessly by the students.



## 2.5 Women Empowerment and Eradication of Hunger

Empowering women will alleviate poverty and eradicate hunger. The women in the rural areas have been taught many skills that could help them make a living and have a good quality of life.





SathyabamaOfficial



SathyabamaOfficial

Sathyabama always believed in the power of women and has a dedicated ‘Women empowerment Bureau’ that works towards women development.



## SDG 3 – GOOD HEALTH AND WELL-BEING



The world has made significant progress, but still faces significant challenges to achieving the 2030 targets for Good Health & Well-Being. Women around the world lack access to sexual and reproductive health care, millions suffer from malnutrition, HIV/AIDS continues to afflict thousands daily, billions of people have no access to life-saving medicine, and we continue to create more waste that will impact the health of all.

Poor health impacts every dimension of human life: lowers access to education and economic opportunities and increases poverty. A cause of poverty, health is also impacted by poverty and Goal 3 is strongly connected to SDGs, such as Goal 1: No Poverty, Goal 2: Zero Hunger, Goal 5: Gender Equality, Goal 6: Clean Water & Sanitation, Goal 13: Climate Action, and Goal 16: Peace, Justice & Strong Institutions.

Sustainable Development Goal 3 seeks to ensure health and well-being for all, at every stage of life. The Goal addresses all major health priorities, including reproductive, maternal and child health; communicable, non-communicable and environmental diseases; universal health coverage; and access for all to safe, effective, quality and affordable medicines and vaccines. It also calls for more research and development, increased health financing, and strengthened capacity of all countries in health risk reduction and management.

- Studying disease epidemiology, drug discovery by bio prospecting natural resources from by screening to identify potential anti-infective leads.
- Understanding the disease burden and better understanding of the disease pathogenesis
- Monitoring factors that affect human health and well-being, like air quality and traffic
- Supporting health promotion and disease prevention, through the use of wearable monitoring devices

- Enabling remote/rural healthcare and ensuring continuous support until the disease is completely eradicated.

Overall, we can contribute to the Good health and wellness of peoples through education, outreach programs, hospitals and service. The Institution offers courses like dentistry, biotechnology, biomedical instrumentation, microbiology and nursing, in health-related professions and dedicated research centres like Centre for Drug Discovery and Development, Centre for Laboratory Animal Technology and Research and Centre for Nanoscience and Nanotechnology. We have published more than 37 research articles in national and international journals during the assessment period highly relevant to SDG goal 3.

### 3.1. Collaborations to improve health and well being

Our institution has active collaboration with local, national and global institutes and hospitals to improve the health and well being. We are signed MoU with Health Institutes and companies like National Institute for Research in Tuberculosis (ICMR) And Vivagen Dx for TB drug discovery and diagnosis research, Deepam Hospitals, ICON Life Sciences, GE Health care and the Government of Tamil Nadu student training and skill development, American College and the Loma Linda University, USA for Health care product development.

<b>Name of the Collaborating health Institutions</b>	<b>Level (Local/ National/ Global)</b>	<b>Nature of collaboration / Outcome</b>
National Institute for Research in Tuberculosis (ICMR) Chennai – 31. Tamil Nadu	National	Research collaboration for anti TB drug discovery
Nanyang Technological University	Global	Research collaboration for TB Diagnosis and anti TB drug discovery
Vivagen Dx	National	Drug Discovery and Diagnostics
Deepam Hospitals, Chennai	Local	Student Training
ICON Life Sciences, Chennai	Local	Student Training, Entrepreneurship
GE Health Care	Global	GE Training and skill development
The American College, Madurai, TN	Local	A method of Preparing Transdermal wound healing patch from Herbal extracts

Loma Linda University USA	Global	METHOD FOR PREPARING BIOFORTIFIED SEAWEED CHOCOS CHIPS
Government of Tamil Nadu	Local	Dental Screening, Treatment and Referral at peripheral Health Center, Shollinganallur, Chennai

The Centre for Drug discovery and Development at Sathyabama Institute of Science and Technology is actively involved in the SDG3. The vision and mission of the centre focus on exploring the natural resources (microbial and plant) for screening them to identify and isolate potential anti-infective agents for TB and HIV. The centre has received funding for nearly 4 crores in the past for combating the fight against infectious diseases and management.



The Ministry of Human Research Development- Support partnership for academic research collaboration (MHRD- SPARC) (2019-2021) project - PI Dr. Krupakar Parthasarathy Scientist D was awarded for Identification of biomarkers for the development of rapid diagnosis of by quantum dot bio-imaging pulmonary tuberculosis 15.03.2019 amount sanction **Rs. 77,610/-** Further to this a MoU with Nanyang Technological University, TU) One of the world's top leading university in Asia Singapore initiated in 2018 to strengthen the academic and research partnership for

The Scheme for Promotion of Academic and Research Collaboration (SPARC) by MoE- GoI (Ministry of Education- Government of India) Previously MHRD (Ministry of Human n Resources Development) aims at **improving the research ecosystem of India's Higher Educational Institutions by facilitating academic and research collaborations between Indian Institutions and the best institutions in the world** from 28 selected nations to **jointly solve problems of national and/or international relevance**. The scheme proposes to enable productive academic co-operation by supporting the following critical components that can catalyze impact making research, namely:

- ✓ Visits and long-term stay of top international faculty / researchers in Indian institutions to pursue teaching and research from Sathyabama- India and NTU-Singapore.
- ✓ Visits by Sathyabama students for training and experimentation in premier laboratories in NTU Singapore.

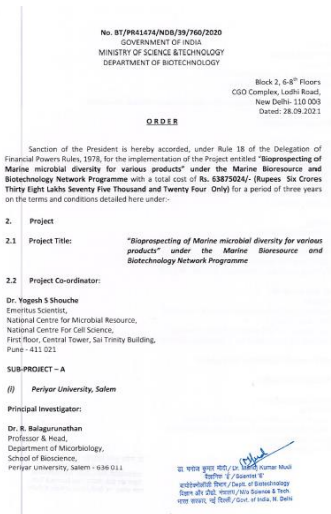

- ✓ Joint development of niche courses, world-class books and monographs, translatable patents, demonstrable technologies or action research outcomes and products with NTU Singapore.
- ✓ Consolidation of Bilateral co-operation through academic and research partnerships related to tuberculosis diagnostics and therapeutics development and also conducting Indo-Singapore Workshops in India.
- ✓ Publication, Dissemination and Visibility through a high profile annual international Conference in India.
- ✓ Thrust Areas: Convergence, Sub Domain: Affordable Health Care

**Sanctioned Amount : Rs. 48,77,610/- For 2 Years (2019-2021)**

### Anti infective Drug Discovery from marine Microbes:

Department of Biotechnology (DBT) funded research project on “Bioprospecting of marine microbial diversity for various products – Sub Project A: Exploring marine actinobacteria for anti -infective and industrial Products” to the PI: Dr. M. Radhakrishnan to discovery novel molecules to fight against drug resistant *Mycobacterium tuberculosis* and biofilm forming bacterial pathogens with the funding Rs. 48,66,160/-.

### 3.2. Outreach Programme and projects

The Institution has its own General hospital and Dental Hospital that offers medical treatment to the nearby community at a very reasonable rate. Awareness Programmes are conducted on various physiological and psychological health issues and life style diseases like hypertension, diabetes, stress, depression. Awareness programmes on Cancer, particularly breast cancer and cervical cancer are conducted for women. Dental camps and medical camps are also organised for the benefit of the people in the neighbouring community.

<b>Title of the event</b>	<b>Target Audience</b>	<b>Organized by</b>	<b>Date</b>
International Online Faculty & Student Development Programme on “Translational and Interdisciplinary research in human Diseases Management”	Students and faculty members	Centre for Drug Discovery and Development	24-29.07.2020
Unnat Bharat Abhyaan (Installed a Health Kiosk which gives the vital body parameters)	Thenmelpakkam Village, Tamil Nadu	Dept of Biomedical Engineering	Jun 2021
Covid – 19 Specialty Dental practice during & post pandemic	Students and General public – 641	Sathyabama Dental College and Hospital	14/05/2020 - 16/05/2020
Webinar on Lifestyle Management during Lockdown	Students and General Public – 240	Sathyabama Dental College and Hospital	27.06.2020
Webinar on Intermittent Fasting for Heart Health	Students and General Public – 260	Sathyabama Dental College and Hospital	25.06.2020
Dental screening camp	Sri Sankara Play School, Neelankarai, Tamil Nadu	Sathyabama Dental College and Hospital	2020
Dental screening camp	Hotel Ibis/Novotel Siruseri	Sathyabama Dental College and Hospital	2020
CONS -ENDO day 2020 – Awareness on Dental Trauma	Indian association for conservative dentistry & endodontics ; Conservative dentistry and endodontics association Tamil Nadu	Sathyabama Dental College and Hospital	2020
Awareness on menstrual hygiene and eco-friendly alternatives to menstrual hygiene	Shrunkhala NGO	Sathyabama Dental College and Hospital	2020
CONS -ENDO day 2021 – Awareness programme on Dental Trauma	On account of Conservative Dentistry and Endodontics day 2021 various activities were conducted in Sathyabama Dental college and Hospital with concepts related to specialty, which includes Rangoli, Sketching/Painting, Carving, Poetry, Posters, Memes, Short-films and post graduate clinical case presentations to create awareness among the patients on oral health.	Sathyabama Dental College and Hospital	2021

### 3.3. Sharing Sports facility for Local community

In Sathyabama, Sports activities has been very well supported with and High end sports Infrastructure for the welfare of the students and staffs of the institute. Sports director involved in conducting periodic regional, state, national and International level games such as basket ball. Also Sports centre trains internal and external students for national level sports such as Volley ball, Cricket and Bat Minton. Below in the list of sports facilities which are available for Students in Sathyabama.

## SPORTS FACILITIES AVAILABLE

- ✓ INDOOR AND OUTDOOR BASKETBALL COURT
- ✓ VOLLEYBALL COURT
- ✓ CRICKET GROUND WITH NETS
- ✓ FOOTBALL GROUND
- ✓ HOCKEY GROUND
- ✓ HANDBALL GROUND
- ✓ INDOOR BADMINTON AND TABLE TENNIS
- ✓ INDOOR GAMES ( CHESS,CARROM )
- ✓ 200mt TRACK FOR ATHLETICS & FIELD EVENTS
- ✓ STATE OF ART FITNESS STUDIO

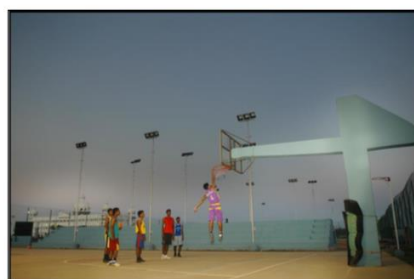

### 3.4. Information and healthcare services for sexual and Reproductive Healthcare

School of Psychology, Dental Sciences and Centre for drug discovery sathyabama involves in conducting awareness programs on HIV-AIDS and also on reproductive health care Ex. Endometriosis and cervical cancer. In addition renowned Gynecologists visit the departments to provide awareness students and staffs on Menstrual cycle and pregnancy related problems.



## SATHYABAMA

**INSTITUTE OF SCIENCE AND TECHNOLOGY**  
(DEEMED TO BE UNIVERSITY)  
Accredited with Grade "A" by NAAC  
Jeppiaar Nagar, Rajiv Gandhi Salai, Chennai- 600 119, Tamil Nadu, India.



**CENTRE FOR DRUG DISCOVERY AND DEVELOPMENT**



**THE WORLD ON THE CROSSROADS OF INFECTIOUS DISEASES**  
Date: 2<sup>nd</sup> December 2020 Time: 10.00 AM – 1.00 PM

- ☐ Invited talks by National and International Experts
- ☐ E- poster & slogan competitions on TB, HIV and COVID-19
- ☐ Cash Award and Certificate for E- Poster and Slogan winners
- ☐ Registration link :
- ☐ Registration Fee: Rs. 250/- [payment through .....]
- ☐ Zoom link will be shared to all the registered participants
- ☐ E-Certificate for all the registered participants

**PATRONS**

Dr. MARIAZEENA JOHNSON, Dr. MARIE JOHNSON,

### 3.5. Access to mental Health support to student and staff

Department of Psychology of sathyabama Institute offers a special program for counselling students and staffs related to mental health as shown below. In addition Centre for drug discovery and development organizes programs related to Yoga for mental well being of the students and staffs.

**SATHYABAMA**  
INSTITUTE OF SCIENCE AND TECHNOLOGY  
(DEEMED TO BE UNIVERSITY)  
Accredited with Grade "A" by NAAC  
Jeppiyar Nagar, Rajiv Gandhi Salai, Chennai- 600 119, Tamil Nadu, India.

**CENTRE FOR DRUG DISCOVERY AND DEVELOPMENT**

**Yoga**

Cordially invites you all for the special Webinar program on  
"Yoga for Mental and Respiratory Health"  
Date : 20<sup>th</sup>- 22<sup>nd</sup> July 2020  
E-Certificate will be provided to all participants  
Join Zoom Meeting <https://zoom.us/j/9467392036>  
Meeting ID: 946 7399 2036  
Free Registration: <https://forms.gle/KGHai26MRsGEhXwY6>  
**GUEST SPEAKERS**

20.07.2020 11am to 12.00pm	21.07.2020 11am to 12.00pm	22.07.2020 11am to 12.00pm
Mr. Arul Perumal, M.Sc., (Yoga) Krishnamacharya Yoga Mandiram , Chennai	Dr. E. Manigandan, M.Sc.(Yoga), PGDYE, Ph.D. Yoga Praveetha, Kanchiammai Vivekananda Centre Kanchipuram	Mr. Sudharson Raghavan Shishya Yoga Kanchipuram

**PATRONS**  
**Dr. MARIAZEENA JOHNSON, CHANCELLOR, SIST**  
**Dr. MARIE JOHNSON, PRESIDENT, SIST**

**ADVISORS**  
**Dr. T. SASIPRABA**-Vice Chancellor  
**Dr. S.S.RAU**- Registrar

**CONVENER**  
**Dr. WILSON ARUNI**- Pro Vice Chancellor

**ORGANIZING SECRETARY**  
**Dr. S. Kumaran**  
**Scientist C**

**ORGANIZING MEMBERS**  
**Dr. Joseph Jerrine**  
**Dr. T. Rajasekar**

Nature of support (Counselling/Course/Programme)		Enclose the Proof document separately
Student Counselling and Psychological Support Centre	Department of Psychology	<a href="https://www.sathyabama.ac.in/student/student-counseling-psychological-support-centre">https://www.sathyabama.ac.in/student/student-counseling-psychological-support-centre</a>
B.Sc (PSYCHOLOGY)	Department of Psychology	<a href="https://www.sathyabama.ac.in/admissions/programs-offered">https://www.sathyabama.ac.in/admissions/programs-offered</a>
Webinar on Yoga for Mental and Respiratory Health On 22-23.07.2021	Centre for Drug Discovery and Development	
Teacher student communication and interpersonal skills – 21-24.07.2020	Sathyabama Dental College and Hospital	

### 3.6. University Smoke Free Policy

Sathyabama University is implemented with smoke free policy. In addition The department of Public health and dentistry has established Tobacco cessation counselling center. Periodic camps has been conducted in campus and also in the surrounding villages to give awareness on the serious impacts caused by smoking. Awareness has been given to public and also the students. This is done collaboration with Government hospitals.

TCC: Tobacco cessation counselling center.



### 3.7 CDDD PUBLICATION in 2019 for SDG3- No's (10)

S. No	Title	Authors	Journal name	Volume; Page No	Year	Month
1.	Anti infective potential of marine actinobacteria against carbapenem resistant Klebsiella pneumoniae ATCC13882	Sukanthkumar E, Vijayalakshmi G, Manigundan K, Bharathi S, Gopikrishnan V, Jerrine Joseph, Radhakrishnan M	Research J. Pharmacy. and Technology	13(8); 3653-3660	2020	Aug
2.	Antimicrobial and antitubercular activity of endophytic actinobacterium, Streptomyces sp. SACC 4 isolated from the mangrove plant Rhizophora apiculata	Ayswarya, S., G. Vijayalashmi, A. Vignesh, K. Manigundan, V. Gopikrishnan, S. Anbarasu, Jerrine Joseph, and M. Radhakrishnan	Bioscience Biotechnology Research Communications	13(3); 1050-1054	2020	Sep



S. No	Title	Authors	Journal name	Volume Page No	Year	Month
3.	Evaluation of inhibitory activity of bacteriocins from <i>Enterococcus italicus</i> BLN48 against <i>Mycobacterium fortuitum</i> and its toxicity profiling	Revathy K., M. Radhakrishnan* and S Anbarasu.	Biosci. Biotech.Res. Commun.	25(1); 6715-6721	2021	Jan
4.	In vitro screening of antimicrobial, antioxidant, cytotoxic activities, and characterization of bioactive substances from freshwater cyanobacteria <i>Oscillatoria</i> sp. SSCM01 and <i>Phormidium</i> sp.	Prasanna Balaji Niangua, AnahasPerianaikaM atharasiAntonyraj, Kumaran Subramanian, SowparthaniKaliyaperumal,Sureshgopal, Pugazhvendan Sampath Renuka, Wilson Aruni	Biocatalysis and Agricultural Biotechnology	29; 101772	2020	Oct
5.	In silico docking studies of phytomolecules as anti-breast cancer agent	Keren Deborah S, Raghavi R, Jerrine Joseph, Jemmy Christy and Wilson Aruni.	Biosci. Biotech. Res. Comm.	13(2); 431-437	2020	June
6.	Antibacterial efficacy of <i>Streptomyces maritimus</i> SACC-E6 against carbapenem-resistant <i>Klebsiella pneumoniae</i> ATCC BAA-1705	Radhakrishnan M., Vijayalakshmi G., Gopikrishnan V, Suresh A., Manigundan K, Jerrine Joseph.	Journal of Applied Pharmaceutica l Science	11(01); 089-094	2021	Jan
7.	Inhibitory activity of marine actinobacterial extracts against Dengue-2 virus	Lavanya, D., M. Radhakrishnan and P. Krupakar.	Research J Biotechnology	Vol. 16 (1) January (2021).	2020 - 2021	
8.	Bio-prospecting of marine actinobacteria for siderophore production and antibacterial activity against multi drug resistant gram negative bacterial pathogens.	Ayswarya S, Manigundan K, Vijayalakshmi G, and Radhakrishnan M*.	Journal of Environmental Biology	43; 223-230	2021	Nov

S. No	Title	Authors	Journal name	Volume Page No	Year	Month
9.	In Silico Docking Analysis of Marine Actinobacteria Derived Antibiotic, Grincamycin against the Epigenetic Enzyme Coactivator-Associated Arginine Methyltransferase1 (CARM1).	Sasirekha S., Jerrine Joseph, Radhakrishnan M, Kishore Narayanan and Balagurunathan R	Adv. Biores.,	12(5); 13-16	2021	Sep
10.	Development of nanobiomaterial for wound healing based on silver nanoparticles loaded on chitosan hydrogel	Bharathi, S; Ramesh, B; Kumaran, S; Radhakrishnan, M; Saravanan, D; Saravanan, P; Pugazhvendan, SR; Nalinasundari, MS;	3 Biotech	11(12); 1-14	2021	Dec
11.	Knowledge of smoking and periodontal diseases: A cross-sectional study.	Dr. Saakshi Gulati	Journal of Advanced Medical and Dental Sciences Res	8(11); 229-233	2020	Nov
12.	Knowledge and awareness of Nicotine replacement therapy among dental professionals in India	Dr. Saakshi Gulati	Journal of advanced medical and dental sciences research.	9(1); 123-127	2021	Jan
13.	Association of maternal periodontal health with preterm birth and a low birth weight among newborns: A cross-sectional study.	Dr. Saakshi Gulati	National journal of maxillofacial surgery	12(1); 67-71	2021	Jan
14.	Communication, Counselling and Compassionate care: The Least explored and Challenging Palliative Care approaches among Primary care Physicians.	Dr. Praveena Raman	Journal of family medicine and primary care	10(1); 572-577	2021	Jan

S. No	Title	Authors	Journal name	Volume Page No	Year	Month
15.	Correlation of Pain Score with Ulcer Size in Oral Aphthous Ulcers using 2% Curcumin Gel and 0.1% Triamcinolone Oral Paste - A Parallel Comparison, Drug Trial.	Dr. Praveena Raman	Journal of Indian Academy of Oral Medicine and Radiology.	33(1); 53-59	2021	Mar
16.	Topical Curcumin and Triamcinolone in Aphthous Ulcers.	Dr. Praveena Raman	The Journal of Contemporary Dental Practice	21(8); 884-890	2020	Aug
17.	Tobacco awareness with socioeconomic status and pictorial warning in tobacco cessation- An exploratory institutional survey in a semi urban population	Dr. Praveena Raman	The Journal of Contemporary Dental Practice	21(10); 1122-1129	2021	Oct
18.	An intelligent detection and therapeutic device to support sleep apnea in infants	Sindu Divakaran, T.Sudhakar, Sindhiya R, Rimisha Gupta, and J Premkumar	ITM Web of Conferences	37; 01006	2021	-
19.	Classification of Digital Dental X-ray Images Using Machine Learning	Divakaran, S., Vasanth, K., Suja, D. and Swedha, V.	IEEE Xplore	1-3	2021	Mar
20.	A Safe and Comfort Bed for Cerebral Palsy Babies-Bedstead	Divakaran, S., Janney, J.B., Sudhakar, T., Snowfy, W.A.J., Morais, M.M. and Krishnakumar, S.	Journal of Physics	1937(1); 012019	2021	June
21.	Automized Pharmacy Using Face Authentication	Premkumar, J., Sughasri, K., Preethi, A. and Kavitha, E.	Journal of Physics	1937(1); 012024	2021	June

S. No	Title	Authors	Journal name	Volume Page No	Year	Month
22.	Wearable EMG Sensor for Gait Rehabilitation using IoT	Bethanney Janney J, Sindu Divakaran, Kezia George, Chandana H, & Caroline Chriselda L.	International Journal of Research in Pharmaceutical Sciences (IJRPS)	11((SPL 4), 2675–2680	2020	-
23.	Recognition of dicrotic notch in arterial blood pressure pulses using signal processing techniques	Janney, J.B., Umashankar, G., Krishnakumar, S., Chandana, H. and Chriselda, L.C.	Journal of Physics: Conference Series	1937(1); 012034	2021	June
24.	Automatic melanoma diagnosis and classification on dermoscopic images	Emalda Roslin, S. and Premkumar, J.	Computational Intelligence in Healthcare	271-285	2021	May
25.	Sleep Disorder Diagnosis using EEG based Deep Learning Techniques	Sudhakar, T., Krishnan, G.H., Krishnamoorthy, N.R., Janney, B., Pradeepa, M. and Raghavi, J.P.	IEEE	1-4	2021	Mar
26.	Silver-Calcia Stabilized Zirconia Nanocomposite Coated medical grade stainless steel as Potential Bioimplants	Kaliaraj, G.S., Thukkaram, S., Alagarsamy, K., Kirubaharan, A.K., Paul, L.K., Abraham, L., Vishwakarma, V. and Sagadevan, S.	Surfaces and Interfaces	24; 101086	2021	June
27.	Drug Retrieving System in Hospitals Using Robotics	Sudhakar, T., Krishnan, G.H., Umashankar, G., Divakaran, S., Bhurnima, U. and Shanchita, B.	Biomedical & Pharmacology	13(3); 1239-1244	2020	Sep
28.	Antimicrobial effect of Sargassum plagiophyllum mediated gold nanoparticles on Escherichia coli and Salmonella typhi	T. Stalin Dhas, Sowmiya, Ganeshkumar, M. Ravi, K. Suthidhiran., Francis Borgio, Narendrakumar, Ramesh kumar, V. Karthick Vineeth	Biocatal. Agric. Biotechnol.,	26; 101627	2020	July

S. No	Title	Authors	Journal name	Volume Page No	Year	Month
29.	Temporal Changes in key developmental transcription factors in dopamine neurons during MPP+ induced injury and recovery in the zebrafish brain	Jayshree Nellore, JayakrishnaTippabathani	Indian Journal of Biophysics and Biochemistry	58(1); 45-55	2021	Feb
30.	Fostering a deeper understanding of COVID-19-associated mucormycosis - A commentary on "The mucormycosis coinfection in the context of global COVID-19 outbreak: A fatal addition to the pandemic spectrum	MohanaSundaram, A., Sathanantham, S.T., Chinchole, V., Patil, B. and Velayutham, R.	International Journal of Surgery	94; 106110	2021	Oct
31.	Harnessing immunotherapy to combat COVID-19: A modern snake oil or silver bullet? 2021 Jul-Aug;	Gunjegaonkar SM, Shanmugarajan TS, Arunsundar M, Arjun UVNV, Devi K, Wankhede SB, Ravichandiran V.	Therapie.	76(4):335-345.	2021	July
32.	A review on the need of advanced clinical pharmacy education services for diabetes prevention and management in India in comparison with international standards	A. Porselvi	Research Journal of Pharmacy and Technology (RJPT)	14(1); 493-500	2021	Apr
33.	Hepatoprotective effect on methanolic extracts of Tagetes erecta leaves and Tridax procumbens against drug induced hepatic injury	Chandra, A.S. and Shanmugapandiyani, P.	International journal of research in Pharmaceutical Sciences	12(2); 1415-1421	2021	May

S. No	Title	Authors	Journal name	Volume Page No	Year	Month
34.	Evaluation of hepatoprotective effect of ethanolic extract of Physali ixocarpa against rifampicin-isoniazid induced hepatotoxicity in wistar rats	N. Delhiraj , M. K. Jaganathan,A. R. Vijayakumar	International Research Journal of Pharmacy	11(10); 17-22	2020	Nov
35.	Hepatoprotective Activity of Thalictrum Foliosum (Ranunculaceae) Root Ethanolic Extract	Gregory Marslin and Jose Prakash	International Journal of Life science and Pharma Research	10(3); 8-11	2020	July
36.	Cardioprotective efficacy of Tagetes erecta methanolic extract in doxorubicin induced oxidative cardiac damage	Aithamraju Satish Chandra and P. Shanmugapandiyan	International Journal of Life science and Pharma Research (IJLPR)	10(3); 73-77	2020	July
37.	Bioanalytical method development and validation of doravirine, lamavudine and tenofovir disoproxil fumarate using HPLC in human plasma	Marakatham, S. and Shanmugapandiyan, P.	Research Journal of Pharmacy and Technology	14(8); 4087-4091	2021	Aug

## **SDG 4 – QUALITY EDUCATION**



The mission of Sathyabama Institute of Science and Technology is to provide quality education to the students and develop qualified manpower for the Nation. The Institution offers courses in Engineering, Science, Technology, Arts, Management, Dental, Nursing and Law and develops professionals.

The Institution encourages quality research and publications on these subject areas. Faculty members and the research students publish articles on thrust areas of the Engineering, Science, Technology and Management.

Sathyabama takes efforts for inclusive education that provides access to education to everyone. It offers education opportunity for all that include diverse ethnic, religious, socio-economic, cultural group without discrimination. Boys and girls from all strata of the society have access to the opportunities. Students across India hailing from different states, speaking different languages study at Sathyabama. Students from neighbouring countries like Nepal, Srilanka and Myanmar study in the Institution. Students from low income Countries like Nigeria, Congo, and Cameroon visit our Institution for pursuing their research.

The Institution offers opportunity for free education to economically backward students. This promotes access to quality education to everyone as financial status is not a constraint. The

desiring students from rural, economically backward section and first generation graduates are given 100% scholarship with free accommodation and food.

#### 4.1 Adoption of Schools

An educated society will always be a developed society. Schooling at primary and secondary level is very important and through good education poverty can be eradicated from the community. The Institution besides taking care of the tertiary or University level higher education of the needy and the downtrodden also takes care of primary and secondary level school education. It has adopted 21 Schools in the nearby community and provide all financial and infrastructure support to develop these Schools. The students are given every possible support and mentored and developed by the Institution. “**Lab on Wheels**” is one initiative of the Institution where Sathyabama’s mobile Laboratory visits the schools regularly.

Sathyabama also takes care of the salary of the Teachers of these adopted Schools.



Signing MOU's with Adopted Schools





The students of Sathyabama also visit the schools, teach the students there, give them motivation and inspire them. When the school students visit the university they are given hands



on training in computers and are really made to

understand the importance of good education. Other than school and college students, Sathyabama aims at educating the adults in the rural areas and in the areas below poverty line with vocational courses to help them have a regular income.

Training students and Adults from Adopted schools & villages

#### 4.2 Adopted Schools and their requirements satisfied for the period 2021

Sl. No.	Name of the School	Requirements satisfied
1	Panchayat Union Middle School, Perumattanallur	Repair works,
2	Panchayat Union Primary School, Venkatapuram	White wash
3	Panchayat Union Middle School, Appur	Repair works,
4	Panchayat Union Middle School , Thenmelpakkam. Singaperumalkoil 603204	White wash
5	Govt.High School, Nellikuppam Road, Kumizhi	LED Display TV
6	Panchayat Union Primary School , Mannivakkam	Repair works,
7	Panchayat Union Primary School, Asthinapuram	Repair works,
8	Panchayat Union Middle School, Nallambakkam	LED Display TV
9	Government High School, Asthinapuram	printer, Laptop

Sl. No.	Name of the School	Requirements satisfied
10	Thanthai Periyar Govt. Higher Secondary School, Puzhuthivakkam	Mike Set
11	Panchayat Union Primary School, Vandalur 600048	Printer, Library Almirah
12	Panchayat Union Primary School, Kumizhi	Computer, Speaker, Amplifier with Hand mike set, Printer
13	Panchayat Union Primary School, Venbakam	Sports Material, Prayer hall Flooring
14	Panchayat Union Middle School, Aalapaakam	Mike set
15	Govt.(ADW) Primary School, Kilambakkam	class room painted by our viscom students for 5 class rooms
16	Govt. High School - Perumbakkam	CCTV Camera
17	Govt. High School - Lakshmipuram	3 teachers salary
18	Govt. High School - Kudimiandithopu	Shed
19	Govt. Higher Secondary School - Chemmenchery	Computer with scanner cum printer
20	Govt. Higher Secondary School - Pallikaranai.	Repair works
21	Govt. Primary school, VANJIVAKKAM	Uniform for 34 students
		Salary for 2 Teachers

### 4.3 Skill Development Centre

Sathyabama Institute of Science and Technology has a dedicated Skill development Centre that conducts various value added skill development courses in association with National Skill Training Institute (NSTI), Ministry of Skill Development & Entrepreneurship (MSDE) with the objective of promoting entrepreneurship and improving the employability of the students.

The Skill development Centre organises and conducts various skill development and vocational education programmes to youths, who are school drop outs and rural women. These training programmes are conducted with the aim of teaching a vocation or skill to the under privileged people, so that they earn their livelihood. Women are trained in vocations like tailoring, baking, beauty and wellness, incense stick making, candle making, mushroom cultivation, sea weed

cultivation and solar lamp making. Men are trained in electrical work, repairs and maintenance of home appliances, laptop servicing and plumbing. These people are also given technical and financial support to start their own business and earn as independent entrepreneurs.



#### **4.4 Centre for Professional and Career Advancement**

Sathyabama Institute of Science and Technology has established a Centre for Professional and Career Advancement through which Online Certificate and Post Graduate Diploma courses are conducted. This centre works with the objective of providing a life-long learning platform for all aspiring learners in order to reskill or up skill their knowledge and become an industry-ready workforce through a systematic approach. This is an initiative to utilize the faculty expertise and the IT infrastructure available in the Institution to provide benefit to the learners across the globe by providing quality online education. This Centre is highly beneficial to students who are not able to continue with the formal college/university education as it provides Skill Based Vocational Courses and Technology Related Courses that expands the opportunities for employment.

#### **4.5 Guidance for Higher Studies**

Sathyabama provides guidance to students for higher studies at top-notch academically and culturally affluent Universities. To prepare the students for higher studies, GRE, GMAT, TOEFL, IELTS, GATE, CAT training is offered by renowned Training Institutions. A separate and well equipped library is set up to provide study material for the students who are preparing for competitive examinations. Sathyabama's Centre for higher studies counsels and supports its students for their enrollment at Universities across the world.

#### **4.6 Jeppiaar IAS Academy**

Jeppiaar IAS Academy is one of the initiatives taken by the Institution with the objective to offer free coaching to students who aspire to become civil servants.



## SDG 5 – GENDER EQUALITY



Sathyabama is an Institution that works consistently towards achieving gender equality which is one of the fundamental rights. It believes that achieving gender equality is essential for developing a sustainable community. The enrolment figures for various programmes of the Institution ensure the equal participation of girls in the education. Sathyabama, as an employer, practice positive discrimination towards employment of women. Women occupy most of the key positions in the Institution and more than 60 % of the staff members are women. The Chancellor and the Vice Chancellor of the Institution are women.

In any committee or club or any forum, the equal representation of girls and women is a strictly followed norm at the Institution. The concept and the ideology of gender equality is deeply rooted in the core value of the Institution. Men and women have equal access to opportunities at The Institution and equally participate in policy making and administration.

Sathyabama Institute of Science and Technology has always been an unbiased institution, merit is based on performance only. With 80 percent of the workforce being women, Sathyabama strives to set out the bias against women in developing countries like India, by tilting the scales a bit towards women. The existence to the “Women empowerment bureau’ the “ Anti-Discrimination Cell”, ‘Human rights cell’, ‘grievance cell’ just goes to prove that the University has always been conscious in seeing that there is no discrimination based on gender.

All outreach activities, and out NSS and NCC cadets are a right mix of girls and boys. All activities are planned to include all the genders. It has been our strength that we not only preach,

but also practice not only Gender equality, but equality to all of mankind, and that reflects in all the activities the University takes up for social causes.



### GENDER RATIO IN OUR UNIVERSITY (Students)

PROGRAMME	NO. OF MALE STUDENTS	NO. OF FEMALE STUDENTS
UG (3 Years)	301	519
UG (4 Years)	6236	3009
UG (5 Years)	314	592
PG ( 2 years)	281	673
PG ( 3 years)	3	11
<b>Total no. of students</b>	<b>7135</b>	<b>4804</b>

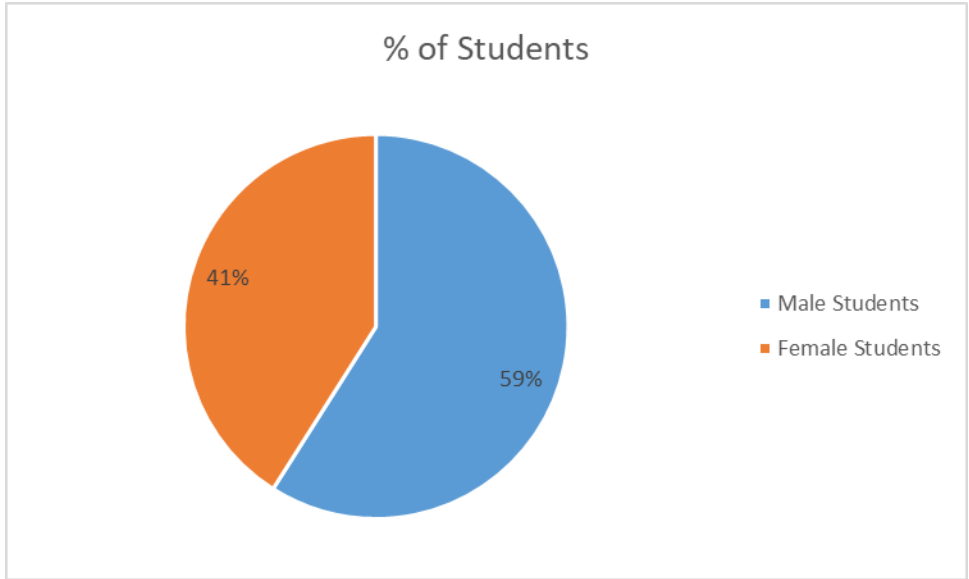

**GENDER RATIO IN OUR UNIVERSITY (Faculty)**

<b>Total faculty</b>	<b>NO. OF MALE FACULTY</b>	<b>NO. OF FEMALE FACULTY</b>
<b>1055</b>	<b>412</b>	<b>643</b>

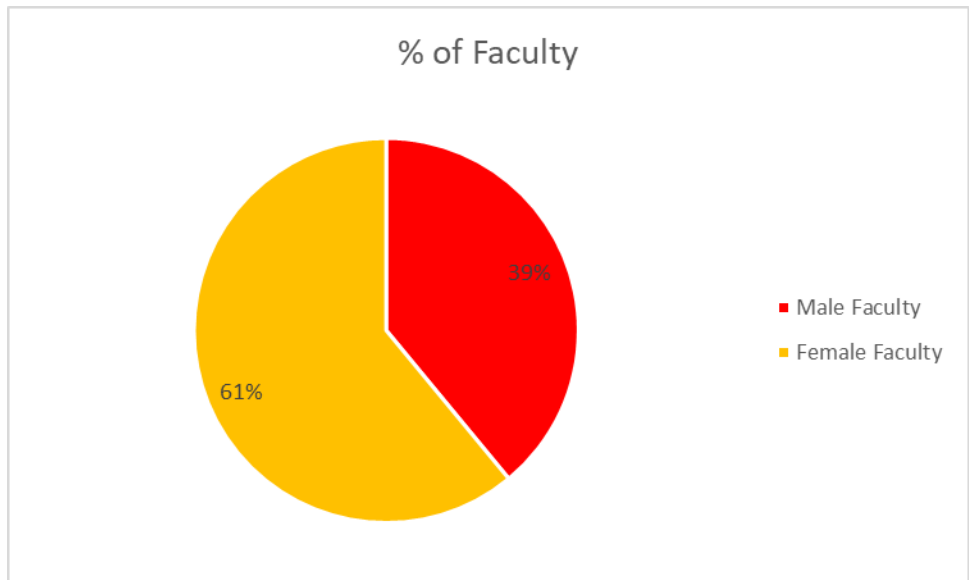



## 5.1 Aims and Goals

The Aim of having the ‘women empowerment bureau’ and many other cells is just to be more mindful about having a balance way of dealing with Students. Staff and the society that we serve. Sathyabama rightly believes that a society that has empowered women, and where equality exists, growth becomes inevitable.

The students participate in Gender equality seminars, webinar and many other programs, but are also made to have hands on experience while they visit villages and the schools that we adopt.

Anbu Foundation the CSR arm of the University was started with the aim of giving free education for girls from poor families. It soon turned out that we had to also consider the boys as in some cases there is no equality when there is poverty. It is because of that, the ratio of girls to boys has been kept higher consciously.



The need for financial independence of women, especially in the economically weaker background is also emphasised and women are trained to become financially independent.

Other major factor is the health. It has been found that in developing countries like India, the people who live below poverty line, especially the women tend to ignore, health and hygiene. Medical camps are held regularly in the college campus as well as in the villages and the schools that we adopted.



## 5.2 Seminars and Workshops

It has been a conscious endeavor and every occasion is used to bring awareness of gender equity. The women's day is an occasion used to send messages of gender equality.

On women's day an exclusive mime was organized by the 'Women empowerment Bureau' to showcase the sexual harassment women with disabilities face, and how as a society we could stand up for them, and how even they can overcome and gain strength. As Sathyabama always have many Hearing impaired students, it was not only an eye opener for them, even the other students realized the difficulties faced by these women. The whole event was put together by a theatre Group 'ACT' and the plays that were enacted were written by an activist, Mr. Gnani who worked for women's rights. The late Mr. Gani and his wife Mrs. Padma Gani have been

empowering women by using street plays, dramas and mime's and we had the privilege of having one his plays enacted in our university.



### 5.3 Gender Ratio among Scholarship Students

The following charts will explain the ratio of girls to boys in the scholarship scheme.

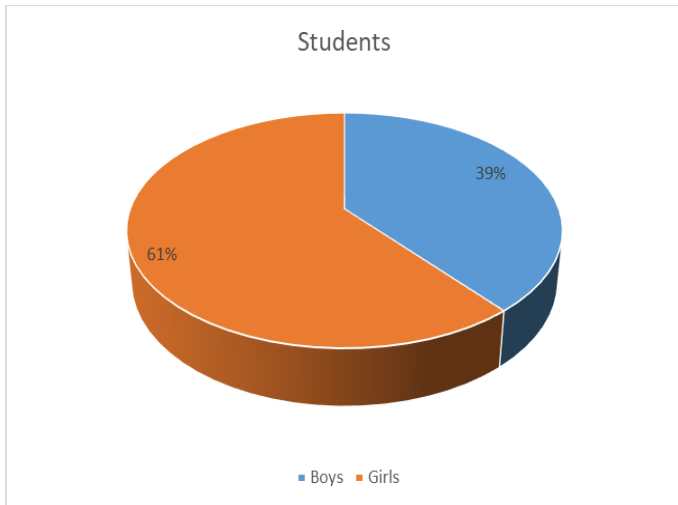

Academic Year	Boys	Girls
2020-2021	258	373
2019 - 2020	231	342
2018 -2019	208	361
Active Students	697	1076

## SDG6: CLEAN WATER AND SANITATION:



### 6.1 Ensure availability and sustainable management of water and sanitation for all

Sathyabama Institute of Science and Technology has taken substantial steps in meeting SDG 6(Clean Water and Sanitation) in terms of noteworthy research publications, innovations, capacity building programmes for students, faculties and through dissemination activities to the rural communities



As per SDG 6.1 and 6.2, By 2030, achieve universal and equitable access to safe and affordable drinking water and access to adequate and equitable sanitation and hygiene for all, initiatives, innovative projects and awareness programmes were conducted especially for adopted villages under the scheme of **Unnat Bharat Abhiyan, Government of India.**

Series of Training programmes are conducted for young and dynamic students volunteers of NCC,NSS, Science club and Women Empowerment Cell in order to educate the rural school students and economically privileged communities to know the importance of sanitation - hygiene behavior and water use efficiency



Sathyabama Institute of Science and Technology NCC cadets from Air force and Navy were recognized for their service under category “WOMEN IN UNIFORM” in the WOMEN’S ICON conducted by Master Mind Foundation.

6.3 By 2030, improve water quality by reducing pollution, eliminating dumping and minimizing release of hazardous chemicals and materials, halving the proportion of untreated wastewater and substantially increasing recycling and safe reuse globally

## 6.2 Prominent initiative taken by the Institution –Establishment of Sewage Treatment Plant

In the state of industry collaboration laboratory facility, Sewage Treatment plant (STP) is established in the year 2019 in association with in-house Department of civil Engineering, Department of Chemical Engineering, Centre for Waste Management and Eco care Engineering Systems Pvt. Ltd to treat about 15 lakh liters of raw sewage water in a day which adopts Sequential Batch Reactor (SBR) process.

Specifications	Details
Freshwater requirement for campus per day	9 lakhs litres
Wastewater generated	7.5 lakhs litres
Source of Water for Treatment	Mess kitchen and hostel toilet water
Capacity of Water treatment facility per day	7 lakhs litres
Usage of treated water	Landscaping and gardening
Outcome	Reducing the freshwater consumption for secondary purposes

**Figure Development of Sewage Treatment Plant for Sathyabama University Campus in Association with Ecocare Engineering Systems and Centre for Waste Management- Innovation Industry Supported Lab**

The STP is equipped with Sensors for Automated control over the SBR design suggested and updated by the Industrial Experts. Further the STP is helpful in performing the case study experiments and research oriented activities. Periodical monitoring is also taking place in the regular interval. The treated water and sludge generated during the treatment process are well utilized for research purpose for characterizing and re usual of water and sludge.



**6.3** Research Publications which supports SDG 6 to improve water quality by reducing pollution, eliminating dumping and minimizing release of hazardous chemicals and materials, halving the proportion of untreated wastewater and substantially increasing recycling and safe reuse globally

Raja, Umer Khalifa Saleem; Ebenezer, Vinitha; Kumar, Amit; Sanjeevi, Prakash; Murugesan, Murali, Mass mortality of fish and water quality assessment in the tropical Adyar estuary, South India Environmental Monitoring and Assessment

Rawat, K.S., Jeyakumar, L., Singh, S.K., Tripathi, V.K. Appraisal of groundwater with special reference to nitrate using statistical index approach, Groundwater for Sustainable Development

Vijayalakshmi, P., Eshanthini, P., Vanitha, S., Sharath Kumar, R., Vigneshwaran, B.Reduction of strength of domestic wastewater using natural fibrous materials, Rasayan Journal of Chemistry

Mahato, B.N., Krithiga, T.Efficient removal of arsenic and chromium from waste water by solvent free synthesized  $\text{Fe}_2\text{O}_3/\text{AISBA-15}$  adsorbent, Materials Today: Proceedings

Vanitha, S., Rajan, N.K. Removal of E.Coli from groundwater and surface water by using nylon membrane filtration technique, Rasayan Journal of Chemistry

S Sathish, K Thamaraiselvan, PA Theenesh, C Venkatesh, TRB Chander, Effect of chrome tanning effluent on cohesive soils

By 2030, substantially increase water-use efficiency across all sectors and ensure sustainable withdrawals and supply of freshwater to address water scarcity and substantially reduce the number of people suffering from water scarcity

Students were encouraged to undergone the internship trainings in the public water supply agencies to understand the water supply processes which is based on the needs and priorities which was evident

## 6.5 Research publications

Subramanian, T. Siva; Abraham, Marykutty ,Computation of aquifer parameters using geoelectrical techniques for the North Chennai coastal aquifer, Indian Journal of Geo-Marine Sciences

Subramanian, T.S., Abraham, M.Assessment of natural groundwater recharge: A case study of North Chennai Aquifer,Environmental Geosciences

Abraham, M., Mohan, S Effectiveness of check dam and percolation pond with percolation wells for artificial groundwater recharge using groundwater models, Water Science and Technology: Water Supply

Nandhakumar, S., Arsheya, S., Kirthika Sri, V.K. (2019) Estimation of rainfall runoff using SCS-CN and GIS approach in puzhal watershed, International Journal of Civil Engineering and Technology

Krupakar, Hitesh Packialakshmi, Investigation of Saline water Intrusion in near coastal zone of Chennai Metropolitan Area

Dr.Nandhakumar- Estimation of Rainfall Runoff Using SCS-CN and GIS in Red Hills Watershed

Dr.Nandhakumar- Design of Efficient groundwater recharge system for Kodambakkam Chennai  
Ms.Eshanthini-Ground water flow modeling using Modflow in Poondi subwatershed

Ms.Shrimathy and Packialakshmi, Assessing the status of groundwater aquifer in and around Marshy Land Area, Chennai, won Best paper Award in the National conference conducted by Centre for Remote Sensing and Geo Informaticsm Sathyabama Institute of Science and Technology, 22-23, Oct 2019

#### **6.4 Innovation which are strongly supporting SDG 6**

Dr. Meera Gandhi-Computer Science Engineering-Automated robot for precision farming with automated Rubber tapping machine, Total Seed Grant/Fund Amount Disbursed to above Idea/Prototype/Innovations Development by Centre (In Rupees)Rs.700000/-Patent applied, Appl. No. 2019 4101 4820

Dr.S.Vigneshwari, Computer Science Engineering Agriculture Drone with Pesticide Sprayer, Patent applied -3169 63- 001- (18-0 4-201 9) Total Seed Grant/Fund Amount Disbursed to above Idea/Prototype/Innovations Development by Centre Rs.400000/-

6.6 By 2030, protect and restore water-related ecosystems, including mountains, forests, wetlands, rivers, aquifers and lakes

Research publications which are strongly supporting



SDG 6.6.1 Change in the extent of water-related ecosystems over time are:

Anusha, N., Bharathi, B., Change detection and flood water mapping using sentinel-1A synthetic aperture radar images, *Journal of Computational and Theoretical Nanoscience*

Thaj Mary Delsy, T., Jamuna Rani, D., Marshiana, D. Health parameter analyses of living organism in underwater environment, *Indian Journal of Public Health Research and Development*

K Nagamani, Y Suresh, [Evaluation of coastal aquaculture ponds using remote sensing and GIS](#)  
NISCAIR-CSIR, India

Research publications which are strongly supporting SDG 6.a By 2030, expand international cooperation and capacity-building support to developing countries in water and sanitation-related activities and programmes, including water harvesting, desalination, water efficiency, wastewater treatment, recycling and reuse technologies are:

Rameshkumar, C.; Senthilkumar, G.; Subalakshmi, R.; Gogoi, Risam, Generation and characterization of nanobubbles by ionization method for wastewater treatment *Desalination and Water Treatment*

Manisha, M.; Mithali, J.; Vijayalakshmi, G.; Gopikrishnan, V.; Masilamaniselvam, M.; Radhakrishnan, M. Bioprospecting of actinobacteria from the Andaman marine ecosystem: Isolation, antagonistic potential, and taxonomy of potential strain, *Indian Journal of Geo-Marine Sciences*

Mathew, R.A., Lavanya, V., Rasiga, S., Abraham, M. (2019) Bioremediation of marine oil spill using beeswax , *Indian Journal of Geo-Marine Sciences*

J Aravind Kumar, D Joshua Amarnath, S Sathish, S Anuradha Jabasingh, A Saravanan, RV Hemavathy, K Vijai Anand, PR Yaashikaa (2019) Enhanced PAHs removal using pyrolysis-assisted potassium hydroxide induced palm shell activated carbon: batch and column investigation, *Journal of Molecular Liquids* 279, 77-87

A Suresh, S Sathish, G Narendrakumar, Electrocoagulation of azo dye containing synthetic wastewater using monopolar iron electrodes and the characterization of the sludgem *Water Practice & Technology* 14 (3), 587-597

Ms.Shrimathy (Final Year Student)- Investigation of water quality and treatment using aquatic plants in and around Ranipet, Vellore

### 6.5 PATENT FILED RELATED TO SDG 6

Ms.Vanitha- Climatization Process in Residential Building Using Geo Exchange System – FILED

6.b Support and strengthen the participation of local communities in improving water and sanitation management



## SDG 07 AFFORDABLE CLEAN ENERGY



### 7.1. Clean, Green and Renewable Energy

Clean energy works by producing power without having negative environmental impacts, such as the release of greenhouse gases like carbon dioxide. A lot of clean energy is also renewable, including wind power, some hydro resources and solar powered energy generation. Clean energy is energy that comes from renewable, zero emission sources that do not pollute the atmosphere when used, as well as energy saved by energy efficiency measures. Most green energy sources are renewable, not all renewable energy sources are seen as being green. For example, hydropower is a renewable resource, but some would argue that it is not green, since the deforestation and industrialisation related to the building of hydro dams can damage the environment.

Humans have been using fossil fuels for decades, meaning that the switch to clean energy has been relatively recent. As a result, renewable energy sources are still seen as being unpredictable and do not yet meet our global power demands. This means that renewable energy is still being topped up with carbon-based energy sources. However, it is believed that our energy needs can be balanced by the efficient storing of renewable energy so it can be used when the demand is present. A great deal of work is being done to improve the infrastructure and storage capabilities of clean energy, with experts saying that clean renewable energy could replace fossil fuels by 2050.

There are financial benefits related to clean energy, not least due to the creation of work to improve the infrastructure, manufacture clean energy solutions and install and maintain them. Renewable and clean energy are growth sectors as the world begins to move away from fossil fuels, meaning that more opportunities will arise in areas ranging from eMobility to power generation and storage.

The expertise that comes with developing these next generation power solutions can be of benefit of those that attain it, offering work and contracts to those who are slow to take up clean energy.

Of course, the financial implications of clean energy are just part of the story, since the real incentive behind clean energy is creating a better future for the planet. But, as fossil fuel use declines, so will the associated financial rewards, meaning that clean energy is not just good for the environment but it is a forward step for industry too.

## **7.2 Clean Energy Sources and Potentials**

Clean energy can be obtained from a variety of sources which, when put together, could create solutions for all our energy needs.

- Sunlight is the most abundant and freely available energy resource on the planet, in fact the amount of solar energy that reaches the Earth in one hour is enough to meet the total energy requirements for the planet for an entire year. Of course, solar power is limited by the time of day, the seasons of the year and geographical location. Despite this, solar energy is being used on both a large and a domestic level already.
- Wind power is another plentiful source of clean energy, with wind farms growing to provide a good contribution to power. However housing wind turbines are not suitable for all locations.
- Hydro or waterpower is one of the most commercially developed sources of clean energy. This energy source is seen as more reliable than either wind or solar power and allows for the easy storage of the energy that is generated so it can be used in line with demand. Municipal hydro power is also being investigated, meaning that the future could see us all using the flow of water through pipes in our homes to generate electricity. Tidal power is a large-scale version of hydro power and, although it doesn't provide a constant supply of energy, it is highly predictable and reliable.
- Biomass uses solid fuel created from plant materials to produce electricity. Although this energy source still requires the burning of organic materials, this is not wood and is now much cleaner and energy efficient than in the past. Using agricultural, industrial and domestic waste as solid, liquid and gas fuel is not only economical but also has environmental benefits too.

### India's Renewable Energy Target by 2022 (By Source)

Unit: Gigawatts



Graphic© Asia Briefing Ltd.

- Projected Renewable Energy Target by 2022
- The projected Renewable energy target of India is detailed in the Figure above. As of 31st August 2022, Renewable energy sources, including large hydropower, have a combined installed capacity of 163 GW.
- The following is the installed capacity for Renewables:
  - Wind power: 41.2 GW
  - Solar Power: 59.34 GW
  - Biomass/Co-generation: 10.2 GW
  - Small Hydro Power: 4.88 GW
  - Waste To Energy: 0.47 GW
  - Large Hydro: 46.85 GW

India has set a target to reduce the carbon intensity of the nation's economy by less than 45% by the end of the decade, achieve 50% cumulative electric power installed by 2030, and achieve net-zero carbon emissions by 2070. Low-carbon technologies could create a market worth up to \$80 bn in India by 2030.

India's target is to produce 5 MT of green hydrogen by 2030. Green Hydrogen target is set at India's electrolyzer manufacturing capacity is projected to reach 8 GW per year by 2025. The

cumulative value of the green hydrogen market in India could reach \$8 bn by 2030 and India will require at least 50 gigawatt (GW) of electrolyzers or more to ramp up hydrogen production.

59 solar parks of aggregate capacity 40 GW have been approved in India

Solar Parks in Pavagada (2 GW), Kurnool (1 GW) and Bhadla-II (648 MW) included in top 5 operational solar parks of 7 GW capacity in the country

- The world's largest renewable energy park of 30 GW capacity solar-wind hybrid project is under installation in Gujarat
- India offers a great opportunity for investments in RE sector; \$196.98 bn worth of projects underway in India
- Wind Energy has an off-shore target of 30 GW by 2030 with 3 potential sites identified

### **7.3. India's Performance in Clean Energy**

Several millions of people in India do not have access to reliable, affordable electricity and they are often forced to use to kerosene, charcoal and diesel in order to fuel their lives and thus polluting our environment with large amount of greenhouse gases. Also, the utilization of centralized power production from fossil fuels and nuclear energy, grid distribution, and long-distance transmission pose great difficulty to provide clean electricity to far off villages and hilly areas.

India has made a commendable progress in the new and renewable energy production. India is very ambitious in its targets for promoting renewable energy. In India, renewable energy has started playing an increasingly important role in the augmentation of grid power, providing energy access, reducing the consumption of fossil fuels, and helping India to pursue its low carbon development path.

India's renewable capacity installations reached 86 gigawatt (GW) at the end of the year 2019 with wind energy became the biggest contributor with 44 % share in the total renewable energy mix followed by solar with 39 % share. According to the **Ministry of New and Renewable Energy**, Government of India, stands now at 5th Global position for overall installed renewable energy capacity.

The renewable energy has a share of 23.39% in the total installed generation capacity (370GW) in the country up to February 2020. Especially in the last 5-6 years, the solar capacity has been increased from ~2.6 GW to more than 34 GW. Our Indian Government has reduced the solar tariff more than 75% to meet the energy demand. India also embarked upon in setting up world's largest renewable energy programme for ~17 GW till 2022. **Ministry of New & Renewable Energy (MNRE)** is the nodal agency at the central level for promotion of grid-connected and off-grid renewable energy in the country. Ministry's programmes are implemented in close coordination with State Nodal Agencies (SNAs) for renewable energy (RE).

Over the period, the SNAs have developed considerable knowledge and experience in planning and implementation of RE programmes. India is working towards achieving the goal of installing 175 GW of renewable power capacity by 2022 by setting a new target to increase the country's share of non-fossil-based installed electric capacity to 40 % by 2030. With a radical new approach, India is very confident to provide energy access to all people by 2030.

#### **7.4. Status on the Clean Energy Programme at our Institute:**

##### **7.4.1 Centre of Excellence for Energy Research**

The Centre established in 2014, December 9<sup>th</sup> functions to meet the Clean Energy initiatives in the Campus. The centre gives enormous support to the academic initiatives in designing courses and training programmes for the students, promotes cutting edge research in clean energy and strives to translate the research outcomes to the society.

##### **7.4.2 Goals**

Centre of Excellence for Energy research promotes education, training, research and developmental programmes in the novel and newly emerging areas of energy. Solar Cells, Fuel Cells and Bioenergy are the major areas of the Centre is pursuing. The Centre frequently conducts training programmes, workshops, conferences to deliberate on the newer findings in the

energy sector. The Centre also aims to enhance the quality and quantity of basic and applied research programs.

The Centre is established in the International Research Centre (IRC) with Photovoltaics, Surface Physics, Energy Materials, Materials Chemistry, Materials Processing and Bio fuels laboratories housing Raman Spectroscopy (Renishaw inVia Reflex Raman spectrometer), DEKTAK profilometer from ( Bruker, USA), Potentiostat,- Galvanaostat with Impedance Analyser (Biologic, France), Hall Effect measurement system (Ecopia, South Korea), UV-Visible Spectroscopy (Jasco Analytical Instruments), 50L Biodiesel Pilot plant (Malnad Extraction Industries Bangalore, India), and Gas chromatography (YL Instrument South Korea), Hydro Thermal Reactor, Algal photobioreactor.

#### **7.4.3 Initiatives for the Promotion of Clean Energy**

Sathyabama has taken measures to implement clean energy utilization wherever possible. The pathways, the rooftops, waiting sheds are all covered with solar panels for solar energy tapping and utilization. The institution has plans of expanding this in future. The Centre is engaged in research and training of clean energy. It also keenly translates the research outcome to reach society for livelihood enhancement. The biodiesel production is well established in the Centre. Apart from training the graduates of science and engineering discipline, training is also given to marginal and non-workers of Aadhanur and Eachampoondi villages in Cuddalore district for their livelihood enhancement. A Biogas plant is commissioned in the campus to convert food.



**Clean Energy Initiatives in Campus**



## Biodiesel Production and Characterization Facility



50 L Biodiesel Plant



Gas Chromatography-FID/TCD



Cloud and Pour Point Apparatus



Hydrothermal Reactor

## Algal Cultivation Facility for Lipid Extraction for Biodiesel Production



### Training and Capacity Building Activities

#### 7.5. Collaborations established and continued

1. University of Hyogo, Japan – *Perovskite Solar Cells*.
2. Indian Institute of Madras, Chennai, India - *Storage applications*.
3. CSIR-Central Electrochemical Research Institute (CSIR-CECRI) - *Sensor and Storage applications*.
4. Technological Development Unit (UDT), University of Concepcion, Coronel Industrial Park, Coronel, Chile - *Water splitting applications*.

5. Institute of Natural Science and Mathematics, Ural Federal University, Yekaterinburg 620002, Russia - *Development of new magnetic materials.*
6. King Saud University, Kingdom of Saudi Arabia – *Photocatalytic Applications.*
7. National Dong Hwa University, Taiwan- *Solid oxide Fuel Cells to against the* developing research solutions and innovative technology• delivering behaviour change through instilling low-carbon values and habits in our students.
8. Mirai Research Solutions,Chennai – A Startup Company for **design fabrication and commissioning of Biodiesel plant ranging from 20 L to 1000 L capacity.**
9. WasmanPro Environmental Solutions, LLP,Chennai for the implementation of **Waste to Energy Solutions, especially conversion of Food waste to Biogas.**
10. Sree Anchaneya Industries, Thiruvallur **for establishing a novel process for conversion of agricultural biomass to bioethanol**



**Mirai Research Solutions, WasmanPro and Sree Anchaneyas Industries with the Sathyabama team after signing an MoU**



*Sathyabama towards Clean energy.....*

## **SDG 08 DECENT WORK AND ECONOMIC GROWTH**

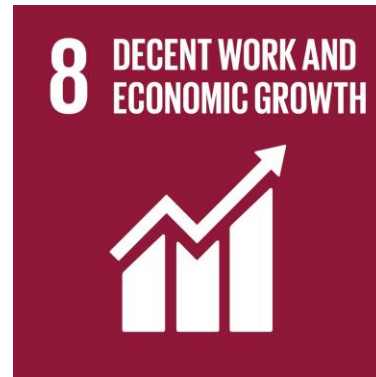

### **8.1 Promote sustained, inclusive and sustainable economic growth, full and productive employment and decent work for all**

The University is committed to long-term goals that ensure creating, promoting and delivering opportunities that enhance the employability of suitable talent and students. Generating a sustainable pipeline of talent, providing access to the right tools and support for employees by giving individuals the platform to excel is critical to the long-term success of the university and its vital contribution to the community.

**Promote sustained, inclusive and sustainable economic growth, full and productive employment and decent work for all** The full productive employment strategy is framed around developing and implementing simple and consistent processes and systems; supporting the evolution of the workforce, their engagement and wellbeing. The employment policies and practices are legally compliant and have enabled the University in retaining employees and sustaining its position as a fair employer since inception.

## 8.2 Graduate Employability

The graduates of Sathyabama Institute of Science and Technology are sought after employees, as reflected in the University's ranking in NIRF (INDIA) and the QS Graduate Employability Rankings 2021.

The University plays an important role in employment of graduates and job creation in India and across the world. Commercialization of the research findings of researchers has a high impact on the employment and entrepreneurial ventures of graduates whose growth and survival rates are above the national average.

## 8.3 Study Programmes

The robust Curriculum design of the University, accredited by National and International Agencies has promoted creation of responsible and ethical citizens. Global initiatives by the UN to promote Corporate Social Responsibility, Sustainable, Green Engineering and Management solutions are being meticulously disseminated through teaching-learning and research practices of the university. Periodic technology upgrades, innovation management and value added courses in the diverse disciplines have paved way for jobs which increase economic productivity.

Special focus on entrepreneurship, creativity and innovation is provided through Technology Business Incubators supported by the Department of Science and Technology (GOI) and Micro, Small and Medium Enterprises (GOI). Approaches fostering mission-oriented, inclusive, social innovation and digitally enabled innovation for sustainable development and growth of formal MSMEs with access to financial services have been enthusiastically acknowledged by various



stakeholders.



#### **8.4 Informal Student employment initiatives**

The “**Earn while you Learn Programme**” launched from 2010 to offer interesting and varied career opportunities for students during their study period is a sought after initiative as it provides opportunities for skill development and work experience. Conscious contribution to basic literacy and open access to existing scientific and technological information, flexible intellectual property rules that allow fair use of physical spaces, online tools with hands-on learning and open repositories of scientific and technological knowledge is being practiced to achieve full and productive employment and decent work for all women and men including young people by 2030.



### **8.5 Integration of persons with disabilities**

With increased attention to the principle of inclusive education for students with disabilities, systematic measures for the conditions in higher education have been incorporated. A transparent, fair and effective method of financing education through specific grants is in practice. Promoting and supporting integration of persons with disabilities through impartial standards regarding equal pay for work of equal value is the motto of the university.

### **8.6 Educational equity and community Development**

Shared accountability and coordinated services integration in education, health and livelihood promotion has led to joint development and welfare of the local community. Various skill Development and Capacity Building programmes for poverty alleviation, promotion of small businesses, financial security, health and hygiene, physical and psychological wellbeing, literacy and safety of individuals for both men and women are being provided for economic inclusion and building up the local community and create assets and wealth for sustainability.

### **8.7 Strategy for Economic empowerment**

The series of reforms and enablers of the Government in the Economic package to make India Atmanirbhar and measures for relief and credit support to businesses, especially MSMEs to support Indian Economy's fight against COVID-19 have been followed to address rural and urban employment generation activities. The startups initiated at the university have been



supported to contribute efficiently to the labour market with a distinct focus on inclusive and indiscriminative approach towards equity and sustainability.



SathyabamaOfficial

## SDG 09 INDUSTRY INNOVATION AND INFRASTRUCTURE



Creativity and innovation are new drivers of every nation's economy. Innovation is important to an organization as much as Quality. With the continuous effect from our active Institute Innovation Council we have secured fifth position in Atal Ranking of Institutions on Innovation Achievements (ARIIA), Ministry of Education (MoE), Govt of India under the self-financed universities category. We have conducted seminar, workshop, conference on regular focus towards innovations, Intellectual Property rights (IPRs), Creativity, Product Design and Development, Design Thinking, System Thinking and Conceiving — Designing — Implementing — Operating — (CDIO).



### 9.1 Centre of Excellence for Collaborative Product Design and Development (CPDD)

The creation of real product is an important for commercializing technologies arising from R&D at technical institutions. For example conversion of a Bolt & Nut from design into product requires 4-8 weeks. The master pattern can be selected only after testing the design of 34 patterns. That master pattern is used for production. Using Rapid prototyping we can select the master pattern in 4-8 hours. The Rapid prototyping requires construction of a mini plant. Institutions mostly lack of mini plant. Most of the Engineering Institutions have keeping Computer Aided Design Lab in different Location and Additive Manufacturing Laboratory (3 D Printer Lab) in different location. In this Situation, Design to Reality is very difficult. In Sathyabama Institute of Science and Technology, We are Integrated Computer Aided Design Lab and Additive Manufacturing Laboratory and developed new centre name as **Centre of Excellence for Collaborative Product Design and Development (CPDD)**. Through this CPDD, we have developed more than fifty products in the year 2019. Sathyabama have more than 20 successful patent/non patent technology transfer.

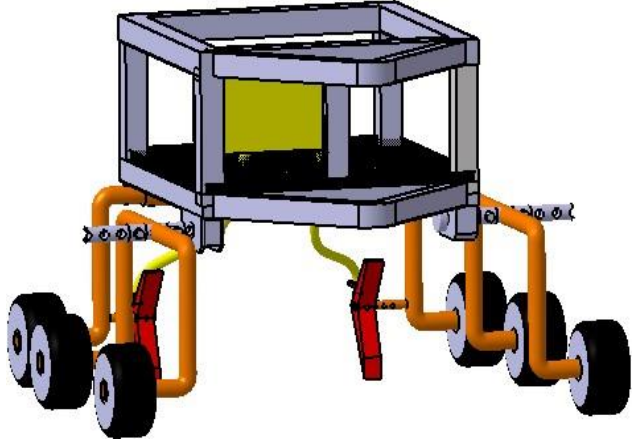
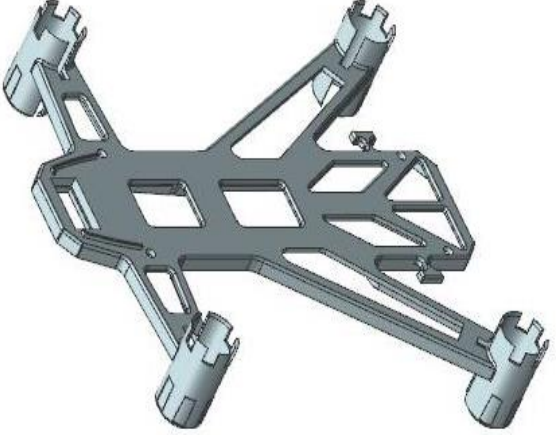
	
Multipurpose Agricultural Robot; Grant No : 317206-001,	Base Plate for Unmanned Aerial Vehicle, Grant No: 316200-001,

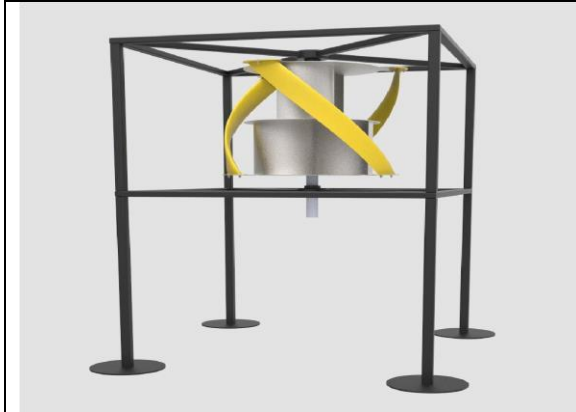

Vertical Axis Wind Turbine Using Gorlov and Savonius Blades for Water Pumping System; Grant No : 294063



Tube Muffler for Light Motor Vehicle; Grant No :304750

Sathyabama is one of the top Indian Industrial Design (Design Patents) grant institutions in India. A growing trend in Intellectual Property Rights with Design Patents grants and Patents Published in effect moving responsibility for innovations.

Product : Extension Power Cord

Technology Transfer : CADD Technologies School of Design Private Limited, Coimbatore

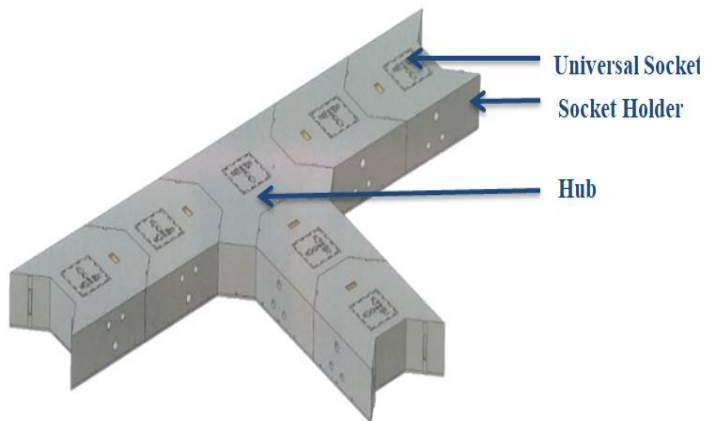

**9.2 Infrastructures for Innovations:** Sathyabama Institute of Science and Technology has ventured into yet another digital initiative “NEXTGEN Lab” to empower students in cutting-edge technology. Pre Incubation and Product Development aspects, Sathyabama developed NI LABVIEW Laboratory, Spectroscopic facilities, Data Science and Centre of Excellence for Robotics and Automation.



NEXTGEN LAB was inaugurated by Prof. Anil Sahasrabudhe, Chairman, AICTE. The lab features advanced technologies such as Augmented Reality (AR), Virtual Reality (VR), Artificial Intelligence (AI), Internet of Things (IoT), Blockchain and Data science.



**Technovation – Technical Fest**



The Center of Excellence for Robotics and Automation was established to cater the automation knowledge needs in the field of robotics and Artificial intelligence. This center has an exclusive Industrial robot of ABB IRB 1520 (6 axis) to perform operations, programming, and advanced control systems.

**Solar Infrastructure :** Sathyabama Institute of Science and Technology has World's Largest Solar Steam Cooking System with 110 concentrator dishes with an area of 1100 m<sup>2</sup> (World's largest installation in terms of the number of dishes and square metres of the reflecting concentrator dishes). A solar-powered kitchen consumes lesser power and time than a conventional kitchen and ensures that a meal is cooked in half-an-hour, whereas it may take one-and-a-half hour to cook the same using LPG. Unlike the LPG model, solar steam cooking system helps to keep the kitchen clean and hygienic. This kitchen, by replacing LPG with solar dishes, saves nearly Rs. 20 lakhs every year. Out of 365 days in a year, Tamil Nadu experiences hot weather for 320 days and is ideal for tapping solar energy.



**9.3 Industry Institute Interaction Cell:** The aim of our Industry Institute Interaction Cell (IIIC) is to strengthen the relationship between industry and our institute, which provides an excellent platform for both the students as well as the faculty members to be aware of industry expectations from the graduates. IIIC serves as a podium to showcase the best practices, latest technologies in industry stand point and their implementation.

Industry Institute Interaction Cell Meeting



**9.4 Executive Development Program:** Sathyabama has well experienced Executive Development Program (EDP) for working professionals entitled with Quality Management, Production Planning, 5 S and Marketing.





## SSDG10 REDUCED INEQUALITIES



### 10.1 INTRODUCTION:

Sathyabama University has always prided itself for its inclusive education. Students from all walks of life, religion, caste, creed and the differently abled too find Sathyabama inclusive. Even our employment policies have no discrimination based on the status of the applicant. The campus is very inclusive for all kinds of physical disabilities. From, ramps to interpreters and Brail books in the library, and the ever friendly attitude of the students and the staff makes inclusive education very easy. Sathyabama also prides in inclusion of high functioning Autistic students, who have benefitted by normal education in a regular college. The inclusion does not end with their academics. Sathyabama's placement Cell takes responsibility to place most of the differently able students in rewarding careers. In short their life is taken care of once they come to Sathyabama.



## 10.2 GOALS:

The main aim is to help differently abled students integrate with the society as a whole and not lose out on anything that the world has to offer. To reduce the inequities that arise due to mental or physical disabilities, social and cultural differences, class differences and overall any differentiation that exists because of inhuman practices.

To help students from socially backward and downtrodden lives to create a future that is worth living. To uproot them from poverty and guide them to a more meaningful life.

To guide children of parents who are disengaged from the society, like prisoners, to be made self-sufficient and have a positive way of looking at life

To be a mentor and support system for students with physical disability to excel in any sport or activity that they are interested in.



Program conducted for Disabled students

### 10.3 Scholarship for Disabled Students:

Free education is offered to students from Ability foundation, an NGO that helps children with disabilities pursue education. Sathyabama has offered 50 free seats every year to Ability foundation. The total number of disabled students pursuing their graduation currently is 80. The hearing impaired students have interpreters who are also recommended by Ability and Sathyabama recruits them to help the students. The visually impaired and the students in wheelchair are also given the attention required. We also have occasional autistic students who have integrated well in the college because of the overall acceptance. Inclusive education for all has been Sathyabama's policy.



#### **10.4 Scholarship for Meritorious Students from Socially and Financially Poor Background.**

Sathyabama has so far helped more than 1200 students from very poor background finish their college education and has elevated their living standards. Sathyabama continues its Altruistic deeds and 2019 had 300 students who have joined us. These students will be given free education, free Hostel facilities and free transport. Some of the students who passed out and are well placed have made their Alma Mater proud by sponsoring students themselves. This compounding effect will make the ripples larger in our society and it brings immense pride to Sathyabama.



Chancellor with scholarship students

#### **10.5 Arrangement with Global Network Equality :( Prisoners Welfare)**

Sathyabama has an arrangement with the GNE (Global network Equality) who work with the prisoners and their children. Every year 25 seats are offered to them free of cost and we have children from broken families and prisoners who are accepted and offered all the facilities offered to the other students, but free of cost. Currently we have 48 students who are prisoner's children who are pursuing their graduation in Sathyabama. These students are given extra attention and care as they have had a traumatic childhood.

## 10.6 Facilities Offered

Starting with Ramps for students in wheel chair to interpreters for hearing impaired sathyabama strives to make life easier for students with disabilities. They are also included in the sports and cultural activities. One of our students Mr. Parthasarathy a wheelchair basketball player was provided with a sports wheel chair and he was selected by London's Titans wheel chair basketball. Sathyabama bore his entire training expenses and his travel and stay there. Acid victim's students have been

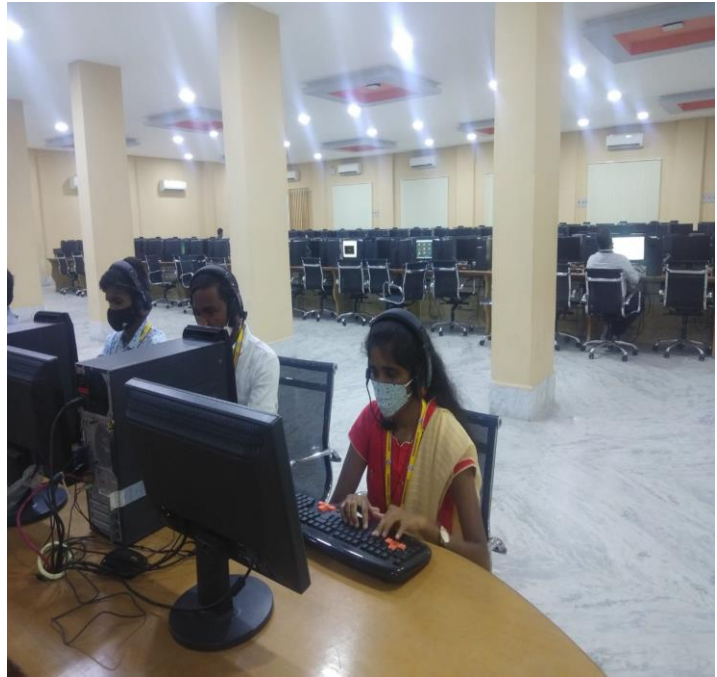

given life skill trainings and also psychological trainings to adapt to their state. The acceptance of those students in the college by the faculty and students has had a positive effect on their self-

esteem and they are also given enough training to face the world with pride. Sathyabama's placement cell also helps them find jobs as soon as they finish their graduation.



grievances are minimized.

## 10.8 Grievance Cell:

Sathyabama has a Student's grievance cell which is a 5 member team. The students can approach the cell for any of their grievance and the matter will have to be resolved in 48 hours. The cell is opened on all days and students can approach them at any time during college hours. Regular meetings are held and the issues are discussed and they try finding ways to see that the

### **10.9 Placements for the Disabled:**

Sathyabama's Placement cell has always tried and placed the students from the inequitable background in good organizations. They have signed an agreement with “youth for job foundation’ which is a foundation that helps disabled students get good jobs. The endeavour does not end there. The placement cell has been conscious of the fact that these students has it rough when they go into the society and hence, special counselling is offered to them and the organizations that recruit them are also given an orientation of how they could be Disability friendly organization. Students from socially weak background are given training in Soft skills.





## SDG11 SUSTAINABLE CITIES AND COMMUNITIES

### 11.1 Leading by example , we provide a sustainable campus



Sustainable Practices within the campus

1. All students and faculty members use sustainable transport means to commute to college, these are through buses that use Bio-diesel generated from waste oil collected from college kitchen
2. Pedestrian-friendly and pollution free campus with natural ecosystem of wetlands surrounding the campus, only battery-operated vehicles are mainly used inside the campus
3. Mass Tree plantation was conducted by college in the area Thiruvarrum and in the college by around 1000 students on 27th Jan 2019.
4. Water treatment plant has been established in the campus that is used for irrigating the landscape in the campus
5. Renewable resources are utilized in the campus like Solar energy for street lighting, charging points, solar heater for hostels.



6. Road traffic awareness program was conducted by students as a NSS activity on 2nd Feb and 9th Feb 2019 in Sholinganallur, Chennai.

## 11.2 Contribution to Sustainable development of city

1. Engineer J . Vanjinathan, Assistant Professor in Department of Civil Engineering has been appointed for State Quality Monitor in TUFIDCO (Tamilnadu urban finance Infrastructure development and corporation).

He was involved in the project appraisal in TUFIDCO (Tamilnadu urban finance Infrastructure development and corporation) for the following projects;

- Development of commercial complex at Thiruvallur theatre under Smart Cities Mission
- Redevelopment of new stand in Vellore City Municipal Corporation under Smart Cities Mission
- Convention center at Tamukkan ground Madurai smart city
- Bridge project under IUDM 2020-21. Alandurai Town Panchayats



2. School of Building and environment signed a **MOU, with ITDP** Institute of Transportation and development policy, Chennai, to collaborate in working towards **planning Sustainable transportation** in Chennai.

Our students worked for **Complete street project** and prepared proposals for pedestrian infrastructure in the influence area of schools in Mylapore and Saidapet areas in Chennai.



---

### 11.3 Centre of Excellence in Urban Climate and Built environment

---

1. School of Building and environment, Department of Architecture has established Centre of Excellence in Urban Climate and built environment which possesses a well-equipped Climatology lab, with instruments like Thermal imagers, data loggers, outdoor data loggers and simulation software like IESVE, ENVIMET etc. , here simulation studies and research works on Sustainable practices topics like building materials, energy efficiency in the building, urban heat island, sustainable landscape planning are conducted and documented.

---

### 11.4 Capacity building programs

---

The University has a continuous cycle of Programs that bring about transformation in the campus through the delivery of state of art research, training and improvement in teaching methods and facilities some of which are;



1. **Faculty development programs**, are conducted, like **Urban Climate and built environment** was conducted in association with Council of Architecture (COA) where all experts from various cities came together and collaborated, shared their knowledge and trained the participants.
2. In order to Strengthen the awareness and efforts to protect and safeguard **cultural and natural heritage of Chennai** city every year **Madras day** is celebrated, conservationists and Architects working in this domain are invited to come and share the experience. Competitions are held were in the culture of Madras is celebrated.

---

## **11.5 Sustainability as an integral part of Academic learning**

---

The Academic learning has been developed with the intent to provide professionals and students with a springboard for invention, knowledge and understanding of the application of an integrated environmental approach in sustainable architecture design.

To equip the students with knowledge to respond to a changing world and environmental challenges for best performance in the Industry as Sustainable Architects, Green Auditors, and Green Building Professionals.

1. School of Architecture offers Post graduation program on sustainable architecture and Building Management. The Sustainable goals have been incorporated in the curriculum and students get exposure through various studies and live experiments conducted.
2. Students in Master program in Sustainable Architecture and Building Management can cater to sustainable city planning and design through their academic curriculum and studios which prepare them for sustainable design and construction, enhancement of building services , Intelligent building management systems
3. Professional Training conducted for Post-graduates and Under-graduate programs enable the students to get exposure by working with renowned Architects, Sustainable Architecture firms, Construction Industry.
4. Under Graduate program in Bachelor of Architecture has been structured to include subjects related to Sustainability like Sustainable Architecture, Energy efficient architecture, Vernacular Architecture, Landscape Architecture, Site planning Conservation.

### **Sustainable development workshops**

1. Green Rating system workshop was conducted for students
2. Bio-Resilient complaint HVAC system can improve the wellness of occupants & Heat load calculations by D. Balaji Partner Shree SRB and Associates HVAC Consultants



3. College is a member of Indian National Trust for Art and Cultural Heritage (INTACH) and participates in the activities conducted by INTACH.
4. Developing the students as Green Professionals that will create more awareness in various cities towards sustainable development



## Rural Studio



## Urban Design Studio

## **1. Urban Studio for IX Semester BARCH students**

As part of the academic exercise, our students participated in identifying issues in the city and give proposals for the same.

As part of urban design studio, transit oriented development proposals, connections and interventions in urban spaces near the upcoming metro station in Chennai was studied and Design incorporated place making principles and integrated the needs of commuters by supporting social interactions and exchange. It reflected the networks role as a social space, the impact of this intervention, and the unforeseen dimension of Architecture and Urban design. The studies were conducted in the neighborhood of proposed metro stations at Sholinganallur, Perungudi, Siruseri, Villivakkam, Vadapalani, Iyyapanthangal.

The output focused on Design of station with proposed amenities for the identified location with a challenge to showcase the Imageability and make an identity for the Chennai city.

Development of Area with connectivity to the adjacent neighbourhood which included Utilization of open spaces and development of vibrant interactive spaces.

## **2. Master Sustainable Architecture Design Studio – study of the building blocks in Sathyabama campus and analysing the building envelope.**

Students in groups studied various building blocks in the campus, the existing conditions were evaluated, took measurements for climate parameters like temperature, relative humidity and wind velocity.

After the analysis through various simulations for the building envelope, material and cost analysis, they proposed design solutions to achieve indoor thermal comfort.

Research papers on this design studio were further published in reputed journals by the students.

## SDG12 RESPONSIBLE CONSUMPTION AND PRODUCTION



With the Centre for Waste Management playing a key role the School of Bio and Chemical Engineering, the School of Mechanical Engineering, the School of building and environment through their research objectives, projects, training programmes and other related activities have always promoted the use of services and products bringing a better quality of life while still pertaining to lesser utilization of natural resources and toxic materials. The institution functions with the focus of developing processes and products that give away lesser waste and pollutant emissions thus meeting the demand of Responsible consumption and production.

The holistic approach of Sustainable Consumption and Production is built around the following objectives:

### **12.1 Objective 1: Decoupling environmental degradation from economic growth.**

The Centre for Waste Management, a Centre of Excellence for Energy Research (Bioenergy) has operated Rs.1,00,00,000/- worth projects and continues to operate projects related Waste to bioenergy Conversion technologies

i) **by pursuing feasibility studies at the lab/bench/pilot scale for the production of biodiesel** from various non-edible sources like jatropha/pongamia seeds; animal fat like beef tallow, Newzealand sheep skin; Microalgal lipids and Waste Cooking Oil of different origin. The studies have resulted in the preparation of Biodiesel from Waste Cooking Oil generated in the Sathyabama Institute of Science and Technology mess, which caters to the food need of about 10,000 inmates. This research measure not only has diverted the use of Waste Cooking Oil for fuel production but has also contributed indirectly to the reduction in usage of conventional petroleum crude (natural resource) for the production of diesel. A 50 litres pilot plant established in the Centre for Waste Management Laboratory produces on an average 90-96%

yield catering to the need of five of the institution's buses to operate with 12% blend. The usage of the blends in the buses have proved successful, the laboratory, bench scale and pilot scale biodiesel produced to have better performance and lower emissions.

ii) **The results have been published in peer-reviewed journals given below:**

- Alok Ranjan, Dawn.S.S, J. Jayaprabakar, N. Nirmala, K. Saikiran, S. Sai Sriram, Experimental investigation on effect of MgO nanoparticles on cold flow properties, performance, emission and combustion characteristics of waste cooking oil biodiesel, Fuel, <https://doi.org/10.1016/j.fuel.2018.02.057> [I.F:4.908]

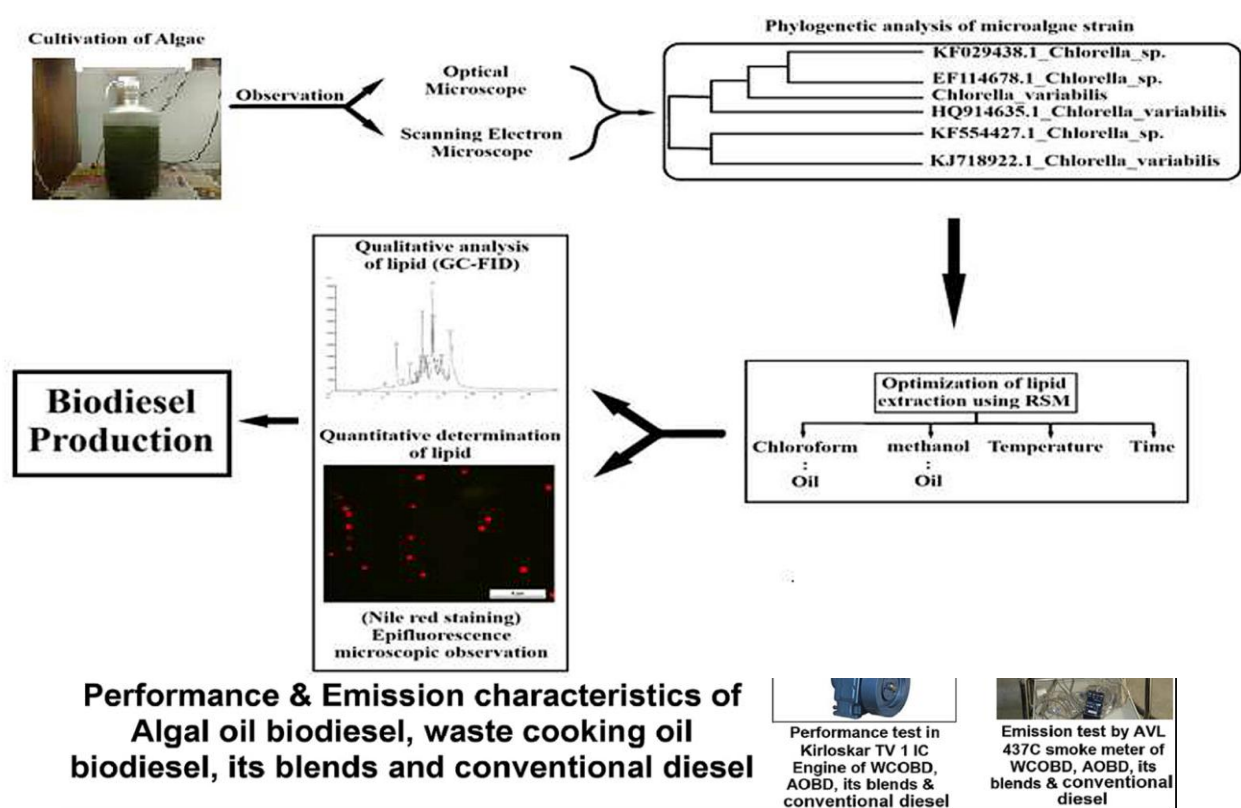

. Jayaprabakar, Dawn.S.S, A. Ranjan, P. Priyadharshini, R.J. George, S. Sadaf, C. Rajeswara Rajha, "Process optimization for biodiesel production from sheep skin and its performance, emission and combustion characterization in CI engine", Energy, ISSN: 0360-5442 [I.F: 4.968]

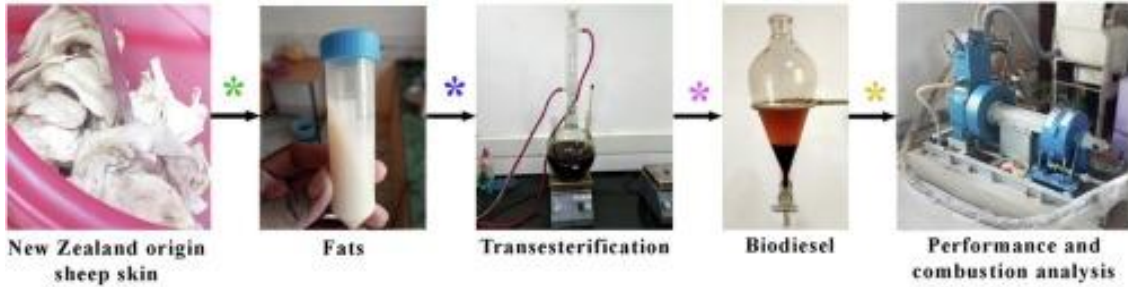

- ✱ - Extraction of fat from New Zealand origin sheep skin
- ✱ - Conversion of fat into biodiesel
- ✱ - Processing of fat for transesterification
- ✱ - Biodiesel for engine testing



Calorific Value : 36,283 (kJ/kg) Diesel : 39,865 (kJ/kg)

Brief Report on Pilot Scale Bio-Diesel Production Plant	
Raw material Used	Mixed Waste Cooking Oil of FFA < 4 %
Operating time	1.5 hours
Temperature	60° C
Methanol to Oil Molar ratio	4.5 : 1
Catalyst	0.5 weight %
Yield	98%

**Patent awaited Technologies in terms of less impact on resource use, environmental degradation, waste and pollution developed in the Centre for Waste Management**

- a) Analysis and Development of Bio Plastic from Algal Biomass for Composites  
201641037330 (First Examination Report submitted)**

**12.2 ABSTRACT OF THE INVENTION**

This project deals with “Formulation of Biopolymer from algal biomass as an alternate to Conventional Plastic” by Using Natural algae biomass”. Algae are predicted to play an important role in tomorrow’s bio economy. Microalgae flourish in municipal wastewater treatment ponds, where they perform a waste purifying function, but harvesting of the algal biomass is generally not practiced, and where it is the chemical flocculants used to remove the algal cells limit further uses of the algal biomass, even for bio fuels (e.g. anaerobic digestion for methane generation). Many research scholars concentrating for the production of bio fuel/bio mass by natural algae. But this project deals about formulation of Biopolymer from algal biomass as an alternate to Conventional Plastic from wasted algae biomass. Wasted algae bio-mass are our raw material for making an alternate conventional plastic. Through chemical synthesis process we are able to make alternate from raw materials. This project is totally new innovation in the area research and development of waste material as well as new composite materials and this could be definitely

useful for common people because of low cost and eco-friendly.



**Automobile components made from algal reject**

- b) Compact Sensor System for Train  
Compartment Washbasin Water Recovery  
201641037331 (Final Examination Report  
Submitted)**



### 12.3 ABSTRACT OF THE INVENTION

In this growing technical era, we are forgetting the elementary thing which supports the existence of human race that is WATER. Now a day the society faces a major problem in the form of “WATER SCARCITY “. But on the other hand we waste a huge volume of water every day at some places. One of such places is the Indian railway where lakhs and lakhs liters of water get wasted every day just after a single use. In India average number of passenger trains running is 12617, which carry about 23 million passengers a day and 8.397 billion passengers annually. At an average 24 coaches are there in a long distance trains. Water is stored in the reservoirs at the time of departure of train (1800 litres/coach) and refilling of tanks is done after 250-450 km. But the water is not efficiently utilized. After a single use it gets wasted on railway tracks and it becomes unfit for further use. The thing is that the water which falls on the track is unable to penetrate even to the water table because of the highly compact concrete and stones which are used while constructing the tracks, so it becomes useless. Water from the wash basins are the major offender of waste water during travel.

In order to meet the demands of water for the growing population of our country we need to harvest this water from being wasted. To do so we can make certain changes in the construction of the water tanks and the wash basins of the trains of India. As per the proposed system the water tanks can be divided into three chambers both of them should be separated by the non-permeable flexible membrane which will also act as the divider between the water (used & fresh) in the tank. As the volume of fresh water decreases, the place to store the filtered used water increases, so in this way the same tank can be used for storing the freshwater as well as the used water. Water from the wash basin is passed through a filter. Purity of the water will be tested at filter outlet.

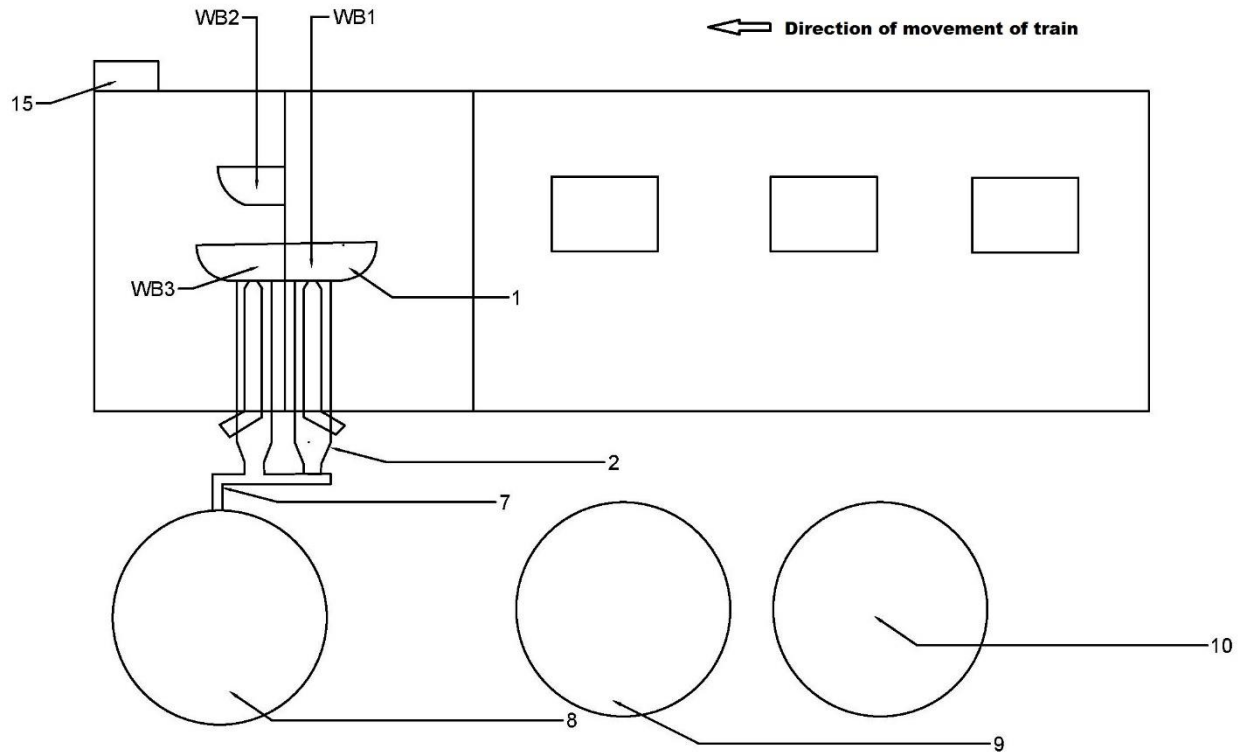

### **Scheme of Wash basin Water treatment in Railway Compartment**

#### **c) Automatic Smart Segregator 201641037332 (First Examination Report submitted)**

#### **12.4 ABSTRACT OF THE INVENTION**

About 0.1 million tonnes of waste is generated in India every day, which is approximately 36.5 million tonnes annually having composition of organic waste- 40-60%, plastic, paper, cardboard, metal, glass- 12-28% and other wastes 12-47%. 95% of the municipal waste collected is dumped on land with only 5% being composted as a result of which the landfill sites are growing drastically, so adverse that even airport authorities' permission is being requested to further extend the height of landfill sites. The researchers suggest for opting a different route of utilizing easily available efficient techniques such as waste-to-waste conversion techniques, recycling processes, bio-gas plant, but the only limitation is that these all demands raw segregated waste for their successful operation and once the organic waste is mixed with inorganic and hazardous waste it's almost impossible to achieve efficient segregation. Establishing segregation plants is limited by need to large area of land, high cost machinery, heavy power requirements, so other way to look into the problem is to ensure source segregation right at the point of origin. We

propose an automatic and smart concept of self-sorting trash bin, which is capable enough to sort the waste into organic waste and recyclable waste.

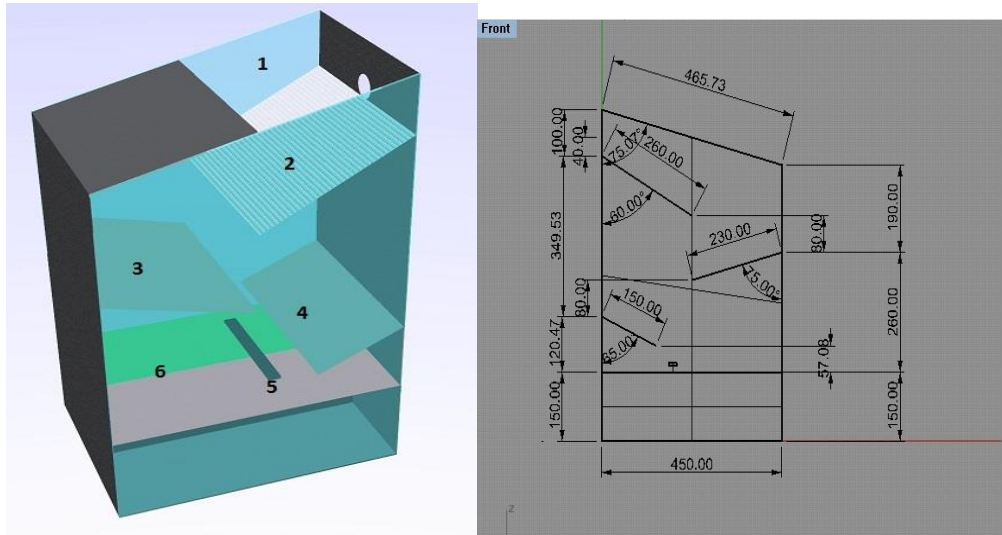

**Configuration of Automatic Smart Segregator**



**SATHYABAMA**  
INSTITUTE OF SCIENCE AND TECHNOLOGY  
Centre of Excellence of Energy Research  
Centre for Waste Management  
One Day Hands-on Training on Biofuel  
Production & Characterization





**SATHYABAMA**  
INSTITUTE OF SCIENCE AND TECHNOLOGY  
Centre of Excellence of Energy Research  
Centre for Waste Management  
One Day Hands-on Training on Gas Chromatography  
GC-FID/TCD



## 12.5 Societal outreach program

Awareness on Waste Management to Self Help Group Women of Kuthambakkam, Poonamalee Block, 24<sup>th</sup> August 2019



## SDG 13 CLIMATE ACTION



### 13.1 WHO WE ARE?

The Centre for Climate Change Studies (CCCS) was established in the year 2011 at International Research Centre (IRC) with the primary mandate of investigating the impact of predicted climate change on marine organisms associated to various ecosystems like coral reefs, sea grass meadows, seaweeds, intertidal zones and mangrove ecosystems etc. In addition, we are committed to achieve United Nation's Sustainable Development Goals (SDGs), mainly SDG 13 and SDG 14 that cover's Climate Action and Life Below Water by 2030.

At present, in the CCCS, the following activities are going-on: (i) Implications of climate change on natural life history traits of coral reef caridean shrimps; (ii) Response of microplanktons to elevated temperature and decreased pH using multidisciplinary approach including proteomics, biochemical and physiological assays; (iii) Contribution of seaweeds towards sustainable future by playing a role in climate change mitigation and adaptation; (iv) Diversity and status of coral reef shrimps in Gulf of Mannar Biosphere Reserve, Tamil Nadu and Lakshadweep and (iv) Plant-insect interaction under climate change scenario. Besides, the Centre is also instrumental in spreading awareness about conservation of marine ecosystem to schools and teachers through citizen science program.

Researchers at CCCS have been actively working at Sathyabama Marine Research Station (SMRS), recently established at Rameswaram to encourage research on cutting-edge marine ecology and climate change to sustainably use, manage, and conserve natural ecosystems for the benefit of the coastal communities of Gulf of Mannar and Palk Bay regions.



## 13. 2 RESEARCH AREAS

### Taxonomy, Genetics, and Eco-biological Studies of Coral Reef Dwelling Fishes and Invertebrates

My primary model systems are coral reef fishes and caridean shrimps, especially when it possesses an ornamental value and symbiotic relationship with other organisms. The representatives of coral reef fishes and caridean shrimps mainly occur in the tropical and sub-tropical latitudes, in shallow-water habitats with the highest diversity found in Indo- Pacific and Atlantic region. This remarkable diversity has driven these organisms to various lifestyle adaptations such as morphological, physiological and behavior. Using a broad approach combining taxonomy, genetics, and eco-biology, we try to answer questions such as:

How the physiology, biogeography, and evolution drive the diversification process in reef organisms in the pan-tropical reefs?

Do these organisms undergo physiological and molecular adaptations to rapidly changing climatic conditions?

How could the ornamental fisheries in India be sustainably utilized for the benefit of fisherman's livelihood and in parallel conserving natural stocks in the wild?

In view of the above, I am working on four major research areas.

#### 1. *Integrative taxonomic approach to document the cryptic species diversity*

This study focuses on revealing the cryptic species diversity in the coral reef associated crustaceans. For instance, the cryptic species complexes of the ‘peppermint’ shrimp *Lysmata wurdemanni* have been revealed based on the integrative taxonomic approach. The main highlights of the research reveal that genetic diversification is not always correlated with phenotypic dissimilarity, resulting in cryptic species complexes that pose a major challenge for biodiversity cataloguing. Resolving these complexes is of utmost importance.

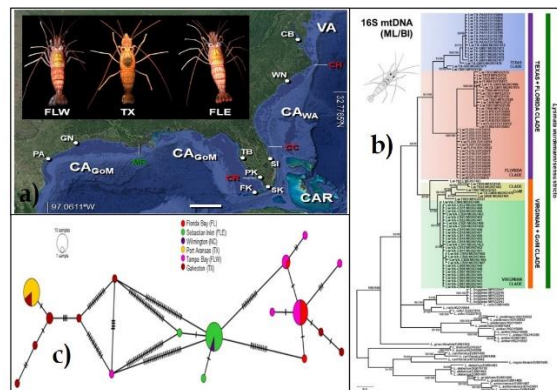
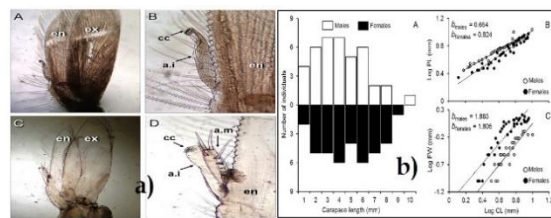



Fig. 1 a) Map showing the study area of *Lysmata wurdemanni* populations in the North Atlantic, Gul of Mexico and the Caribbean Sea; b) Molecular phylogeny (16S-ML) of *Lysmata wurdemanni* showing two major clades: 1. Texas + Florida clade, and 2. Virginia + Gulf of Mexico clade; and c) Haplotype Network analysis of *Lysmata wurdemanni* populations.

## 2. Reproductive physiology of coral reef dwelling caridean shrimps

Caridean shrimps exhibit astonishing diversity in terms of sexual systems. Many species are gonochoric, with populations comprising male and female individuals that never change sex. Various other species are strict protandry hermaphrodites, with individuals undergoing sex change from male to female with increases in size and/or age. Here, I focus on acquiring knowledge on the sexual and mating systems of coral reef dwelling caridean shrimps such as



‘peacock tail’ shrimp *Ancylocaris brevicarpalis* and ‘hinge-beak’ shrimp *Rhynchocinetes durbanensis*, particularly, studying the primary and secondary sexual characters and mating behavior in the laboratory condition. The outcome of this research will help us to elucidate the fascinating evolutionary life history and gender expression in caridean shrimps.

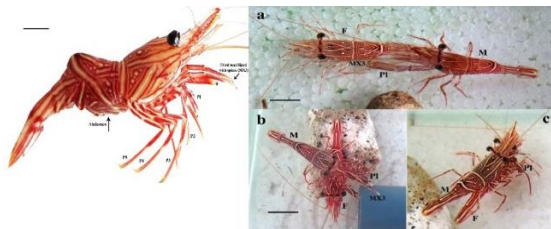
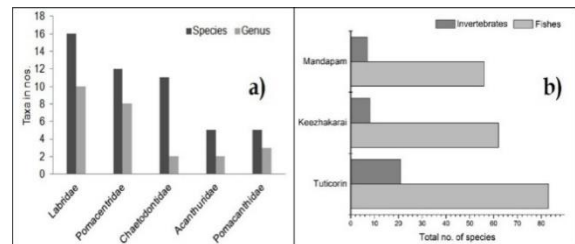

Fig. 2 a) Secondary sexual characters of *Ancylocaris brevicarpalis* female (A, B) and male (C, D); and b) Size-frequency distribution of individuals (A) and relative growth of morphometric characters (B, C)

Fig. 3 Hinge-beak shrimp: *Rhynchocinetes durbanensis*. a, b, c shows the sequence of mating behavior

## 3. Status and exploitation of marine ornamental organisms in Gulf of Mannar, India

Marine aquarium trade is known to improve livelihoods of coastal communities who are entirely dependent on the collection and supply of coral reef ecosystem-associated taxa. However, the market/trade values of various species are known to vary significantly during the different phases of the supply chain, as it must pass through critical stages of quarantine, maintenance, handling and shipping before



reaching the hobbyists. For one year, almost 87 species of fish (51% belonging to the family Pomacentridae) and 21 species of invertebrates were harvested for the trade. The conservation status of exploited species revealed that nearly 50% (n=43) have not been assessed for their extinction risk by the IUCN, while of the 44 species assessed, 41 were Least Concern (LC), and one each was in the Data Deficient (DD), Near Threatened (NT) and Endangered (EN) categories. While many fish were collected, only a few were exported from India. The sea anemones were the major export as they were of a higher value in the international markets, largely attributed to their color patterns. Price discrepancies within the trade value of marine fishes and invertebrates used for the aquarium trade indicated that price increased approximately 200% at each transition in the value chain (collectors to wholesalers, wholesalers to retailers).

Gulf of Mannar being the major hotspot for the collection of coral reef organisms for aquarium trade from India, documentation of species diversity, population trend, harvest potential is a prerequisite for effective monitoring on export trends and endangered species management for sustainable trade in the country.

Fig. 4 Marine ornamental fishes and invertebrates ready for packing in the wholesalers' custody. a, blue damsel *Pomacentrus caeruleus*; b) smoke angel *Apolemichthys xanthurus*; c) sebae clown *Amphiprion sebae*; d) blood shrimp *Lysmata debelius*; e) green carpet anemone *Stichodactyla haddoni*; f) carrot anemone *Phymanthus* sp.; g) finger star *Ophidiaster confertus*; h) sabellid worm *Sabellastarte spectabilis*

Fig. 5 a) Family wise (top 5) species diversity of marine ornamental fishes; b) Region wise species diversity of marine ornamental fishes and Invertebrates

#### 4. Understanding the physiology and molecular adaptations of coral reef dwelling shrimps to climate change

Anthropogenic climate change alters many physical and chemical characteristics that comprise the niches of marine species and ecosystem habitats. Changes in these physicochemical conditions are already leading to shifts in the habitat ranges of some marine species (Cheung et al. 2009), and extinction rates of marine species are expected to increase (Pereira et al. 2010; Cahill et al. 2012). Increasing sea surface temperatures and lowering of pH are a major threat not only to the coral reef ecosystems but also to its associates which provide crucial services in maintaining the health and wealth of the reef systems. Therefore, the aim of this study primarily focuses on the understanding the impact of increasing temperature and ocean acidification on the natural life history adaptations of sea anemone symbiotic shrimp *Ancylocaris brevicarpalis*.

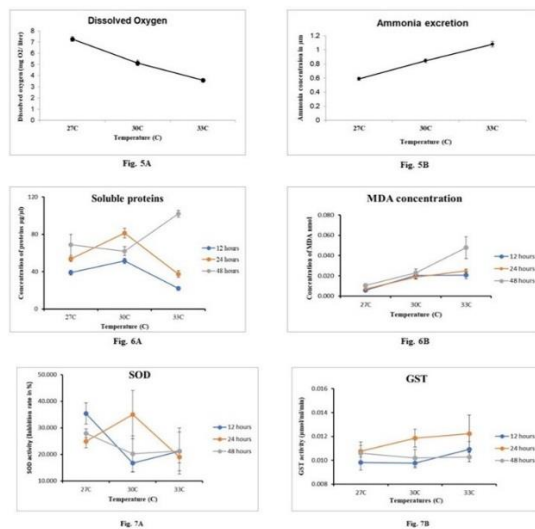

Fig. 6 Changes in biochemical parameters in *A. brevicarpalis* exposed to different temperature

#### References

1. Baeza, J. A. and Prakash, S, An integrative taxonomy and phylogenetic approach reveal a complex of cryptic species in the 'peppermint' shrimp *Lysemata wurdemanni sensu stricto.*, Zoological Journal of the Linnaen Society, 185(4) 2019 1018-1038.
2. Prakash et al., Marine aquarium trade in India: Challenges and opportunities for conservation and policy. Marine Policy, 77 (2017) 120-129.

## Investigation of Responses of Marine Organisms with Respect to Prevailing Environmental Changes

Our research work includes understanding physiological and adaptive response of marine organisms to environmental changes such as ocean acidification and ocean warming. The research also involves studying marine biodiversity using molecular approach taxonomy and systematic approach. The following are the major objectives of our research group.

### 1. Organismal response of seaweeds to climate change stressors and affect at community level.

In collaboration with Stazione Zoologica Anton Dohrn, Naples, Italy and researchers at Antwerpen University, Belgium, we are involved in understanding how brown algae *Sargassum vulgare* is thriving in the natural acidified vents off Ischia Island in the Mediterranean Sea. More recently, we have extended our studies on how biochemical changes in the algae due to climate change conditions may affect their ecological and economic services. In this regard, we have recently published an article entitled “Ocean acidification affects biological activities of Seaweeds: A case study of *S. vulgare* from Ischia volcanic CO<sub>2</sub> vents” in the journal Environmental Pollution. The main highlight of this work includes improved antimicrobial, antiprotozoal, antimutagenic potential, and anticancer activities in the algal extract growing at the acidified site (Fig. 1).

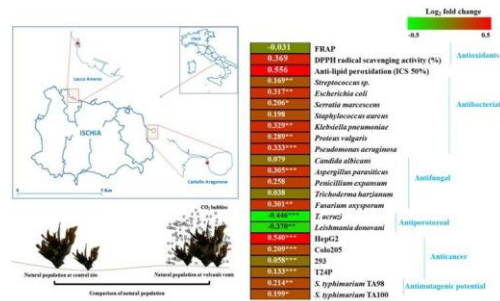

We have also initiated laboratory experiments to investigate tropical seaweed response, mainly *Chaetomorpha* sp. to elevated temperature and lowered pH conditions. We have also been performing no choice feeding assays to investigate feeding rate in amphipods as well as the influence of feed on growth, survival, and reproductive performance of amphipods.

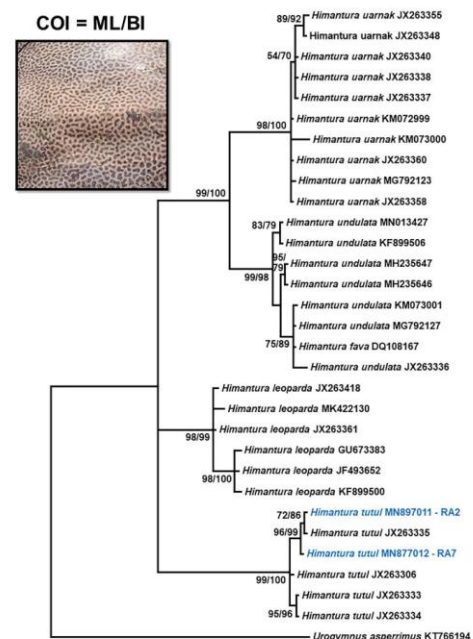

Fig. 1: Graphical abstract highlighting influence of natural acidification on the bioactivities of the brown algae *Sargassum vulgare*

## 2. Inventory, ecology and conservation of marine organisms

We have been making regular visits to the fish landing centre along Gulf of Mannar and Palk Bay as well as conducting underwater surveys in the Palk Bay to observe diversity in the marine organisms and species interactions. One of the recent findings in this regard is the first report of *Himantura tutul* from Indian waters based on DNA barcoding using COXI gene, published in the journal of Applied Ichthyology (Fig. 2). The genus *Himantura* belongs to order Myliobatiformes; Family Dasyatidae has 6 valid species and three of them are classified as “Vulnerable” in the IUCN Red list. Hence, understanding taxonomy, biology and fishery potential of *Himantura* spp. are important for conservation and management practices. We have been performing molecular phylogeny of order Myliobatiformes to ascertain their presence in Indian waters.

Fig 2: Maximum Likelihood phylogenetic tree of *Himantura tutul* based on mitochondrial COI gene sequence.

### Microbial diversity of hypersaline environment and their biotechnological applications

We have been engaged in characterizing bacterial diversity thriving in the high saline conditions and whether these microbes can help us in solving environmental issues, e.g. bioremediation of metals, dye decolorization and degradation, radiation resistance/tolerance for sun-screen. We have recently published “Unveiling Cultivable and Uncultivable Halophilic Bacteria Inhabiting Marakkanam Saltpan, India and Their Potential for Biotechnological Applications” in the Geomicrobiology Journal. For the first time, we utilized third generation sequencer Oxford Nanopore MinIon sequencing to characterize uncultivable bacterial diversity. More recently, we have also identified 11 halophilic bacterial strains capable to tolerate/resist UV-B radiation. We are hopeful that these bacteria can be utilized as a microbial sunscreen for the protection against

UV radiations.

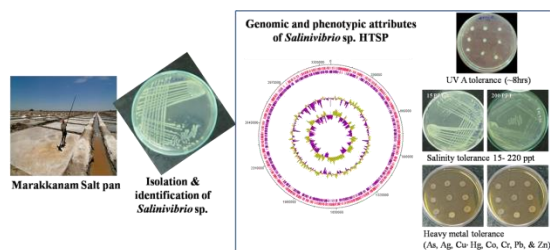
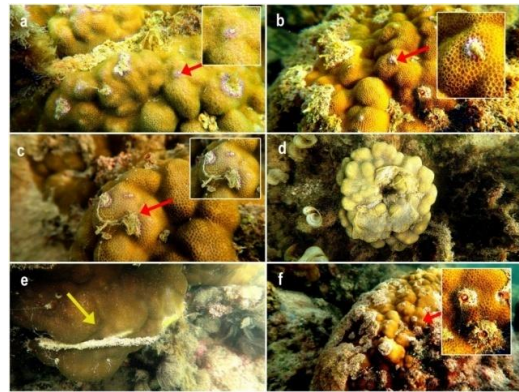

Fig 3: Isolation and characterization of halophilic bacterium *Salinivibrio kushneri* from Marakkanam saltpan.

### 13.3 Coastal Ecosystem Conservation *Coral Associates and Environmental Factors as Potential Stressors to the Corals at Olaikuda Reef, Palk Bay, Tamil Nadu*

The objective of the work is to understand the coral associates as the stress inducing factors for the corals in the Olaikuda reef area, Palk Bay region, Tamil Nadu. The interaction of Polychaete tubeworm and Vermitid snail with *Porites* coral colonies at Olaikuda reef was documented. The Sea Surface Temperature (SST) can combine to have negative interactive effects, even when individual effects are not detectable.



*Porites* coral colonies at Olaikuda reef, Palk Bay region was observed with pink spot and covered with mucus. Close examination of these spots revealed the presence of Polychaete tubeworm and Vermitid snail. The polychaete worm made aberrant growth with pink spot and this would change the growth pattern or morphology of coral colonies. In addition to that, mucus produced by vermitid snail stressed the corals in the Palk Bay region by covering the corals with their sediment trapped mucus. This is the first report of coral associates stresses the coral colonies from Indian waters. These signs indicate the coral reef ecosystem in the Palk Bay region as under stress and if the situation is prolonged, there would be a phase shift in the Palk Bay reef ecosystem. This study also implies the need to improve our understanding of the biology and ecological role of vermetid gastropods, and the mechanisms and their interactions with corals.

**Fig. 1** a) *Porites* colony with pink aberrant growth and conical Polychaete stout; b) tube-dwelling vermetid snail; c) Mucus secreted by vermitid snail; d) The mucus of Vermitid snail covered the top position of a *Porites* colony. e) Mucus thread with sediment; and f) Stressed coral with algal assemblage and vermitid snail tubes.

The focus of the agricultural biotechnology lab, CCCS is on biotic and abiotic stress tolerance mechanism in plants. Our research objectives include i) Mechanism of rice resistance to plant- and leafhoppers (Rice phloem-plant hopper assemblage interaction; ii) Cross talk in defence signalling mechanism of rice plants to biotic and abiotic stress factors and iii) Insect adaptation mechanism to resistant host plants and insecticides. With these objectives, we have been working on different aspects of stress tolerance mechanism in plants with special reference to rice. In January 2019, a polyhouse structure with cooling pad facility was inaugurated by our honorable Chancellor Dr. Maria Zeena Johnson for studying insect-plant interactions.

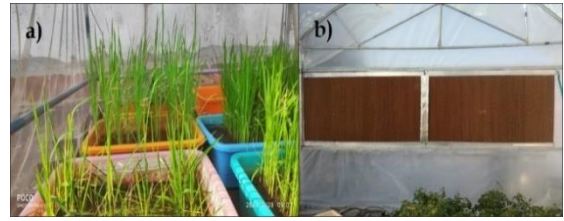

In addition, we studied plant- and leafhopper resistance in rice differentials collected from South Asia and South East Asian countries. The research work was the collaborative efforts of scientists from reputed Institutes and Universities around the world. The study made a clear statement that rice differentials that were tolerant or resistant to plant- and leafhoppers have a higher degree of genetic similarity among themselves indicating a common lineage of resistance. The results of the study have been published in Agronomy journal and have provided lights in improving strategies for the breeding and deployment of resistant rice varieties in Asia. As part of the insect adaptation mechanism objective, we studied the gut microflora of rice green leafhopper (*Nephotettix virescens*) on different host plants with the hypothesis that shift in host plant changes the gut microbial diversity and community structure of leafhoppers. The study was the first to report the gut microbial diversity of rice green leafhopper and was able to reveal that host plant influences the gut microflora of hoppers. The study was conducted at the International Rice Research Institute, Philippines whereas the data curation and analysis were done at Sathyabama Institute and the study was published in Ecology and Evolution journal.



Fig. 1 a) Rice differentials maintained at the polyhouse and b) Cooling pad structure of the polyhouse

Fig. 2 a) Overview of the polyhouse and b) Rice green leafhopper feeding on rice

### 13.4 TEACHING AND LEARNING

We are committed to provide a high-quality education that enables our students to engage with sustainability challenges and to create indigenous solutions to the burning issues of climate change at the local, national and international levels. In support of this, we will encourage organizational training inviting subject experts from different university/institutions towards sustainability-oriented change.

In addition, CCCS join hands with the Centre for Professional and Career Development at Sathyabama to provide curriculum innovation, research-led practice and staff training.

1. UG – Environmental Science and Engineering – SBTA1001
2. Certificate course in Marine Biology and Climate Change
3. Field course in Intertidal Ecology and Climate Change
4. Practical course in DNA Taxonomy and Phylogeny



### 13.5 SATHYABAMA MARINE RESEARCH STATION

Sathyabama Marine Research Station was established in the year 2019 to encourage our researchers to do cutting-edge marine ecology and climate change research to sustainably use, manage and conserve the natural ecosystems for the benefit of the coastal communities of Gulf of Mannar and Palk Bay regions.





The facilities at the marine station include SCUBA diving kits, microscope, underwater camera, plankton nets, PAM fluorometer etc. Marine Station would encourage our



researchers to do cutting-edge marine ecology and climate change research. The facilities will be used to manage and conserve the natural ecosystems sustainably for the benefit of the coastal communities of Gulf of Mannar and Palk Bay regions.

## SDG 14 - LIFE BELOW WATER



The ocean drives global systems that make the Earth habitable for humankind. Our rainwater, drinking water, weather, climate, coastlines, much of our food, and even the oxygen in the air we breathe, are all ultimately provided and regulated by the sea. Careful management of this essential global resource is a key feature of a sustainable future. However, at the current time, there is a continuous deterioration of coastal waters owing to pollution, and ocean acidification is having an adversarial effect on the functioning of ecosystems and biodiversity. This is also negatively impacting small scale fisheries. Saving our ocean must remain a priority. Marine biodiversity is critical to the health of people and our planet. Marine protected areas need to be effectively managed and well-resourced and regulations need to be put in place to reduce overfishing, marine pollution and ocean acidification.

More than 3 billion people rely on the ocean for their livelihoods, and over 80 per cent of world merchandise trade is carried out by sea. Oceans contribute to poverty eradication, sustained economic growth and food security. However, the benefits they provide are increasingly undermined by human activities. Rising CO<sub>2</sub> emissions are driving ocean warming, acidification and deoxygenation, which threaten marine ecosystems and the people who depend on them, and are overwhelming the capacity of oceans to moderate climate change. Overfishing depletes fish stocks, a third of which are already overexploited. Land-based pollutants, including plastic pollution and nutrient and sewage runoff, adversely affect coastal habitats and communities. These changes have long-term repercussions that require urgent scaling up of protection of marine environments, investment in ocean science, and support for small-scale fishing communities and the sustainable management of the oceans.

Sathyabama Institute of Science and Technology has continuously focusing to conserve, mitigate and sustainably use the oceans, seas and marine living resources for sustainable development (SDG 14) through its premier research and development centres like Centre for Ocean Research, Centre for Climate Change Studies, Centre for Remote Sensing and Geoinformatics and Centre for Earth and Atmospheric Sciences.

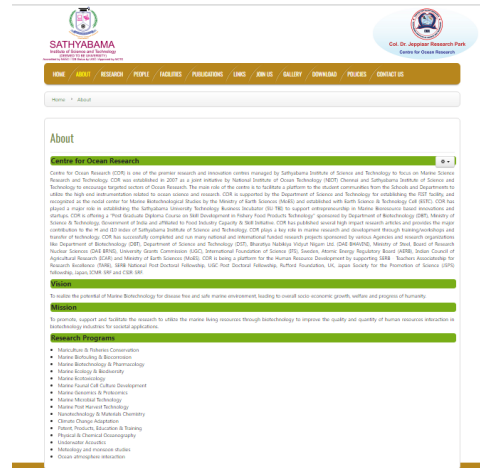

Centre for Ocean Research (COR) was established in 2007 as a joint initiative of National Institute of Ocean Technology (NIOT) Chennai and Sathyabama Institute of Science and Technology to encourage targeted sectors like reduce marine pollution; protect and restore ecosystems; reduce ocean acidification; sustainable fishing; conserve coastal and marine areas; end subsidies contributing to overfishing; increase the economic benefits from sustainable use of marine resources; increase scientific knowledge; research and technology for ocean health; support small scale fishers; and implement and enforce international sea law. The main role of the research center's are to facilitate a platform to the student communities from the various Departments to utilize the high end instrumentation related to ocean science and research as Ocean education is enhanced through scientific cooperation and knowledge at all levels, through the development of research capacity and through the transfer of marine science and technology.

## Target 14.1. REDUCE MARINE POLLUTION

**(By 2025, prevent and significantly reduce marine pollution of all kinds, in particular from land-based activities, including marine debris and nutrient pollution)**

To address the heavy metal/nanomaterials pollution in estuary environment as the target 14.1 a collaborative study was carried out by Centre for Ocean Research, Sathyabama Institute of Science and Technology with Department of Environmental Science, Periyar University, Salem, Tamil Nadu, 636011, India, College of Life Science, Henan Normal University, Xinxiang, 453007, Henan, China, PG and Research Department of Zoology, Sri Vasavi College, Erode,

Tamil Nadu, 638 316, India, and Centre of Advanced Study in Marine Biology, Faculty of Marine Sciences, Annamalai University, Parangipettai, Tamil Nadu, 608 502, India.

The study addressed the marine heavy metal toxicity issues and assessed the accumulation of metal on cuttlefishes (*Sepiella inermis*) from the Mudasalodai Landing Center, from the southeast coastal region of India. Inductively coupled plasma mass spectrometry (ICP-MS) was used to determine metals including aluminium, boron, cadmium, cobalt, chromium, copper, iron, manganese, magnesium, nickel, lead and zinc. The results showed that metal concentration in *S. inermis* detected in the head, arm, mantle, eye, ink, liver and nidamental gland with higher concentration of magnesium up to 992.78 mg/kg, and tentacle showed maximum concentration of aluminium 306.72 mg/kg. Further, copper found in low concentration ranges from 0.04 to 0.55 mg/kg in different parts of *S. inermis*. Heavy metal like cadmium was detected high in the tentacle with 0.24



mg/kg, and the manganese present in the eye was 0.55 mg/kg. However, no accumulation of nickel was found in the tentacle part. The output was reported as publication in the journal Environmental Science and Pollution Research (<https://doi.org/10.1007/s11356-019-07240-1>)

To address the heavy metal contamination in Pulicat lake Lagoon animals such as fishes and to represent the SDG 14.1 target, a collaborative study was carried out by Centre for Earth & Atmospheric Sciences and Centre for Laboratory Animal Technology and Research, Sathyabama

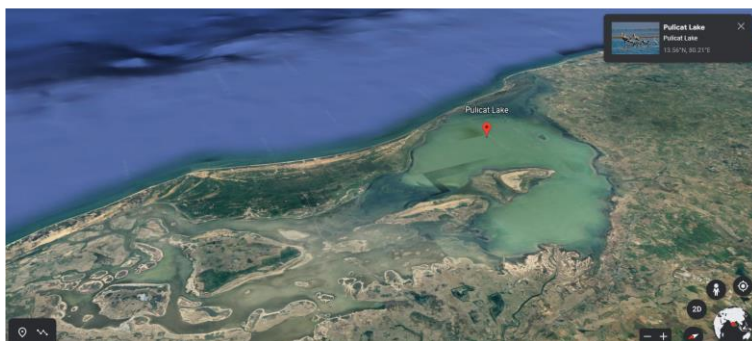

Institute of Science and Technology, Chennai, The study addressed the concentrations of heavy metals namely Pb, Zn, Fe, Cu, Cd and Cr detected in tissue of two fish species (*Pristipoma furcatus* and *Acanthurus strigosus*) collected from Pulicat

Lake, Chennai mixed with effluent from industries in and around north Chennai. The report shows significant results between the organs of *P. furcatus* and *A. Strigosus* but also significant changes observed in all the metals determined in this study. The concentration of heavy metals in

the fish tissue was medium to low. The organs of fish species measured high levels of Lead and Iron. Trace metal levels in edible component tissue of fish were within the limit. This study report indicates the biomagnifications of Pb, Fe and other metals in the aquatic biota of Lake Pulicat. The output was reported as publication in the Rasayan Journal of Chemistry, 2000, Vol. 13 No. 1, pp. 195 – 201.

Biofouling is one of the major issues for marine industries and environment. Antifouling solutions are generally chemicals and metals, which are serious issues that cause pollution to marine ecosystems. The International Maritime Organization already banned these toxic antifoulants as per the SDG 14.1 a target. Centre for Ocean Research, Sathyabama Institute of Science and Technology worked for an eco-friendly solution to stop this marine pollution. The study dealt with the undesirable colonization of anthropogenic surfaces by organisms in the marine environment is stated as marine biofouling.

The biofouling of marine systems is a global concern, with economic impact estimated at billions of dollars. The widely used antifouling biocides including tributyltin tin (TBT) have been previously assimilated into marine paints. Although it has remarkable antifouling performance, it is toxic to the marine environment. Therefore, it is essential to develop eco-friendly antifouling compounds. In the recent times, the physical, chemical, and mechanical properties of nanomaterials have considerably improved the potential applications ranging from environment and energy to healthcare compared with those of bulk materials. Marine antifouling coating is the most effective way for avoiding marine organism attachment till date. However, the cost associated with the commercial antifouling agents and their maintenance is quite high. Therefore, it is indispensable to develop eco-friendly antifouling compounds. The study also suggested eco-friendly methods to produce biopolymer and nanomaterials, and the antimicrobial property of nanoparticles and the unique structure of the biopolymer PHB against marine biofouling. The output was reported as publication in the book, Environmental Biotechnology Vol. 1.

**Production of marine bacterial bioplastic polymer and its nanocomposites for marine Antifouling Application**

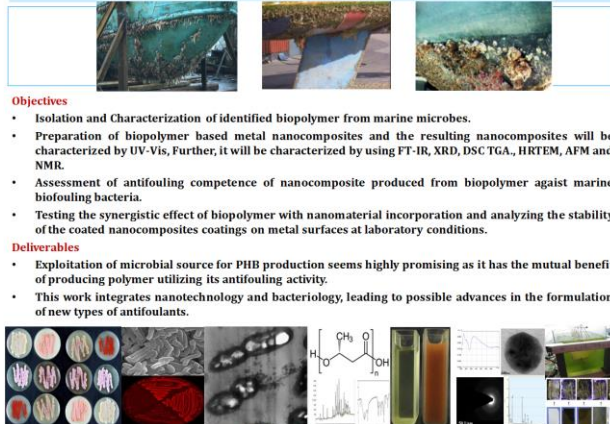

**Objectives**

- Isolation and Characterization of identified biopolymer from marine microbes.
- Preparation of biopolymer based metal nanocomposites and the resulting nanocomposites will be characterized by UV-Vis, Further, it will be characterized by using FT-IR, XRD, DSC TGA, HRTEM, AFM and NMR.
- Assessment of antifouling competence of nanocomposite produced from biopolymer against marine biofouling bacteria.
- Testing the synergistic effect of biopolymer with nanomaterial incorporation and analyzing the stability of the coated nanocomposites coatings on metal surfaces at laboratory conditions.

**Deliverables**

- Exploitation of microbial source for PHB production seems highly promising as it has the mutual benefit of producing polymer utilizing its antifouling activity.
- This work integrates nanotechnology and bacteriology, leading to possible advances in the formulation of new types of antifoulants.

Environmental Chemistry for a Sustainable World, vol 44. Springer, Cham.  
([https://doi.org/10.1007/978-3-030-38192-9\\_7](https://doi.org/10.1007/978-3-030-38192-9_7))

Nuclear Power Plants use the seawater as their cooling circuit during the production. Fouling during the cooling process is a big menace during electricity production. Accumulation of the biological organisms block the path of the entry of the intake seawater and that will be controlled by chlorination. The impact of the biocide is a serious issue to the marine ecosystem on the non-targeted organisms. The



biocide usage and the ecosystem assessment is jointly studied by Centre for Ocean Research, Sathyabama Institute of Science and Technology and Biofouling & Biofilm Processes Section, Water & Steam Chemistry Division, BARC Facilities, Indira Gandhi Centre for Atomic Research Campus, Kalpakkam.

<https://www.sathyabama.ac.in/sites/default/files/2020-12/web%20advt%20jrf.pdf>

<https://indiabioscience.org/orgs/sathyabama-institute-of-science-and-technology/jobs/junior-research-fellow>

The planned objectives the research grant is to determine the concentration of biocides (Chlorine Vs chlorine dioxide Vs active bromide) required to prevent settlement of green mussels (*Perna viridis*) in the PSWHX conduits of MAPS, to determine the concentration of biocides (Chlorine Vs chlorine dioxide Vs active bromide) required to kill different age groups of adult green mussels (*Perna viridis*), to optimize the biocide inventory i.e. (continuous / intermittent / pulse regimes) for cooling water system based on the physiological response of mussels, and to evaluate the efficacy of different antifouling coatings on the settlement of the green mussel (*Perna viridis*). Board of Research in Nuclear Sciences (BRNS), Government of India has sponsored this research grant (Sanction No. 56/14/03/2020-BRNS/36152) to support the SDG target 14.1 a.

## Target 14.2.PROTECT AND RESTORE ECOSYSTEMS

(By 2020, sustainably manage and protect marine and coastal ecosystems to avoid significant adverse impacts, including by strengthening their resilience, and take action for their restoration in order to achieve healthy and productive oceans)

As eutrophication, nutrient run off to the ocean and plastic accumulation are the major problem indicated in 14.1, a collaborative work has been carried out by Centre for Ocean Research, Sathyabama Institute of Science and Technology with National Institute of Ocean Technology (NIOT) to study the growth response of the diatom Chaetoceros species to the elemental ratios of Deep Ocean waters. As an ocean thermal energy conversion project in the Indian Ocean is planned to utilize the Deep Ocean Water as one of the resources, the non-utilized Deep Ocean Water with high nutrient content could be used for raising micro algal culture for aquaculture and other marine bio prospecting applications. The sustainable output of the work was published in Estuarine, Coastal and Shelf Science (<https://doi.org/10.1016/j.ecss.2020.106812>).

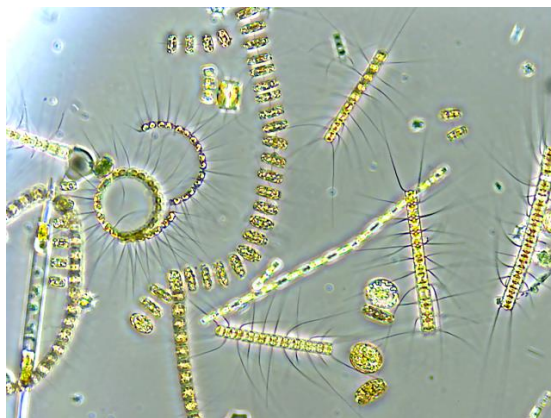

Centre for Ocean Research, Sathyabama Institute of Science and Technology in association with the Ministry of Earth Sciences and Commission on Ecosystem Management, International Union for Conservation of Nature (CEM –IUCN) organized “MARINE FIESTA - An Oceanic Quest”. It was a big chance for school students during this pandemic situation to play in virtual mode and opportunity for School Students (9th, 10th, 11th (+1) and 12th (+2)



standards). To encourage the students the best work was selected and awarded with Young Student Communicator Certificates and participation certificates for all the students. The certificates were jointly issued by Sathyabama Institute of Science and Technology and

Commission on Ecosystem Management, International Union for Conservation of Nature (CEM –IUCN).



The list of Events conducted in the MARINE FIESTA - An Oceanic Quest where as follows;

1. Orate the blues: A one-minute speech contest

Registration link - <https://forms.gle/zve1E9R2CuwbW1XD9>

2. Craft out of Waste: Craft contest

Registration link - <https://forms.gle/aiKC4R9pFiuBRqRQ9>

3. Evoke your ideas: A meme/ comic strip creation contest

Registration Link - <https://forms.gle/qGTKW8mMPHn2GU1u5>

4. Awaken your Picasso: A drawing contest

Registration Link - <https://forms.gle/zgMHdsY91ij1ejj38>

5. Nail Down: A Fun Quiz contest

Registration Link - <https://forms.gle/VBssbQHnf2fRSsp1A>

The student winners were appreciated and certificates on the Sathyabama Institute Foundation day & World Habitat (Ecology) Day, 5th October 2020. The virtual workshop for School Students was a program of fun learning through virtual awareness workshops to seed the awareness in school students and make them explore the “marine biodiversity & ecosystem” from home. [https://youtu.be/L\\_eAVFQUuCc](https://youtu.be/L_eAVFQUuCc)



### Target 14.3. REDUCE OCEAN ACIDIFICATION

(Minimize and address the impacts of ocean acidification, including through enhanced scientific cooperation at all levels)

Ocean acidification may have severe consequences for marine ecosystems; however, assessing its future impact is difficult because field observations are limited by their reduced ecologic complexity and sample period, respectively. In contrast, the geological record contains long-term evidence for a variety of global environmental perturbations, including ocean acidification plus their associated biotic responses. Focus on multiple oceanic areas in Gulf of Mannar, including regions where substantial changes in seawater CO<sub>2</sub> chemistry will occur soon, regions where naturally high pCO<sub>2</sub> conditions are found, and regions that are readily accessible or have on-going, related monitoring programs. In this connection, Centre for Earth and Atmospheric Sciences, Sathyabama Institute of Science and Technology carried out a research to know the impact of Ocean Acidification on the benthic calcareous organisms dwelling at Palk Strait, Bay of Bengal.

The aim of the research work is to evaluate the variation in the Ca/Mg ratio in water, sediment and marine organisms and to characterize the key environmental controls on the calcification of benthic organisms and to carry out <sup>210</sup>Pb and <sup>14</sup>C dating studies in core sediments and marine organisms at various depths including Oxygen isotope studies, finally trace the signature of past relative climate changes in order to reconstruct paleo-environmental changes in the region. To support the SDG target 14.3, this research project was carried out with the support of Department of Science and Technology, Science and Engineering Research Board, DST- SERB (Project Reference: EEQ/2020/000376 dated 07 December, 2020)

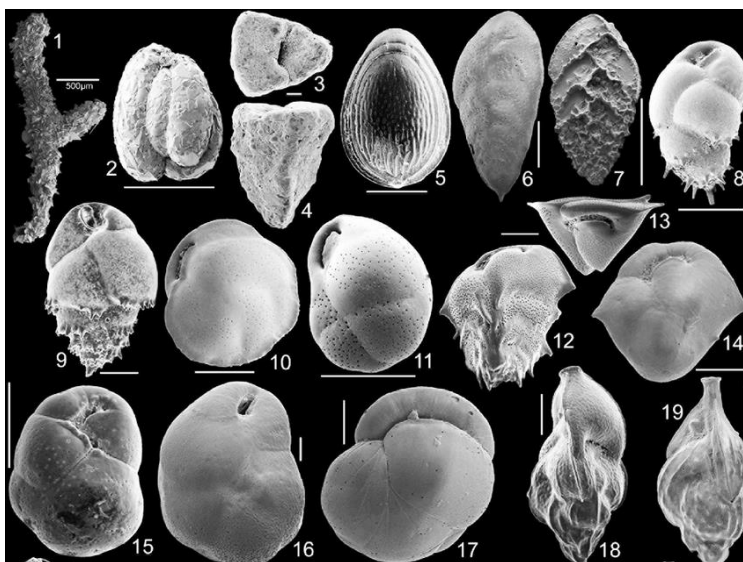

To minimize and address the impacts of ocean acidification, including through enhanced scientific cooperation at all levels and to support the SDG target 14.3, Centre for Ocean Research, Sathyabama Institute of Science and Technology carried out a research by recycling of induction furnace steel slag in concrete for marine environmental applications towards ocean acidification studies. In the present investigation, induction furnace (IF) steel slag as coarse aggregate with 0%, 20% and 40% replaced concrete specimens of size  $150 \times 150 \times 150$  mm was prepared as an initiative to utilize iron-rich IF steel slag. The casted concrete specimens were cured for 28 days at room temperature ( $28^\circ\text{C}$ ) in freshwater, and the obtained compressive strength is 22.5, 24.0 and 29.2 N/mm<sup>2</sup>, respectively. The blocks were then immersed in seawater under laboratory condition for 28 days, and variation in pH was monitored at regular intervals. The composition and mineralogical phases [quartz ( $\text{SiO}_2$ ), iscorite ( $\text{Fe}_7\text{SiO}_{10}$ ), hematite ( $\epsilon\text{-Fe}_2\text{O}_3$ ) and almandine ( $\text{Fe}_3\text{Al}_2\text{Si}_3\text{O}_{10}$ )] present in IF steel slag were identified using XRF and XRD analysis, respectively.

Surface morphology and elemental composition were studied using FESEM with EDAX analysis for before and after immersion of concrete blocks in seawater. Structural bonding of concrete blocks before and after immersion was studied using FTIR analysis. Compressive strength of concrete specimens after the immersion in seawater was evaluated and compared with before immersion in seawater. This initiative will be a major support for induction furnace steel industries via economic benefits. Utilization of iron-rich IF steel slag in marine concrete can be a

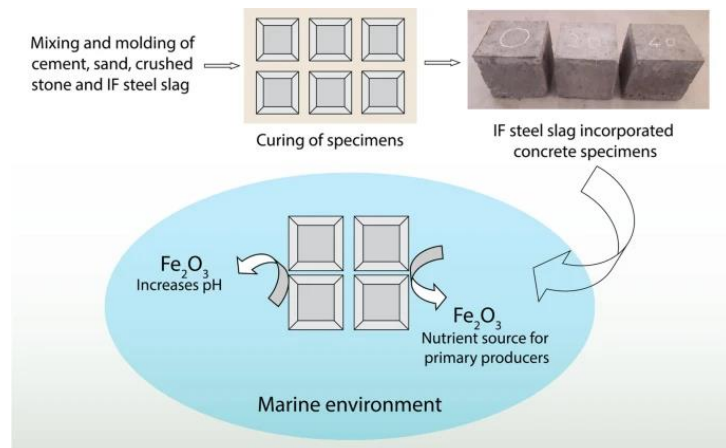

vital candidate for the betterment of marine ecosystems via primary production of marine resources. This study has been published in the International Journal of Environmental Science and Technology. <https://doi.org/10.1007/s13762-021-03362-7>

Aquaculture is majorly threatened by changes in temperature, salinity, precipitation, drought and extreme climatic events (heat waves, cyclones, storms, floods) that affect infrastructure and livelihoods which can impact aquaculture both negatively and positively. The role of environmental stress such as temperature fluctuations, salinity changes, low pH and low dissolved oxygen to stress the host and suppress its immune system have been recognized long back. As a consequence, the incidence of disease outbreaks and rates of pathogen transmission often increase during changes in the environment.

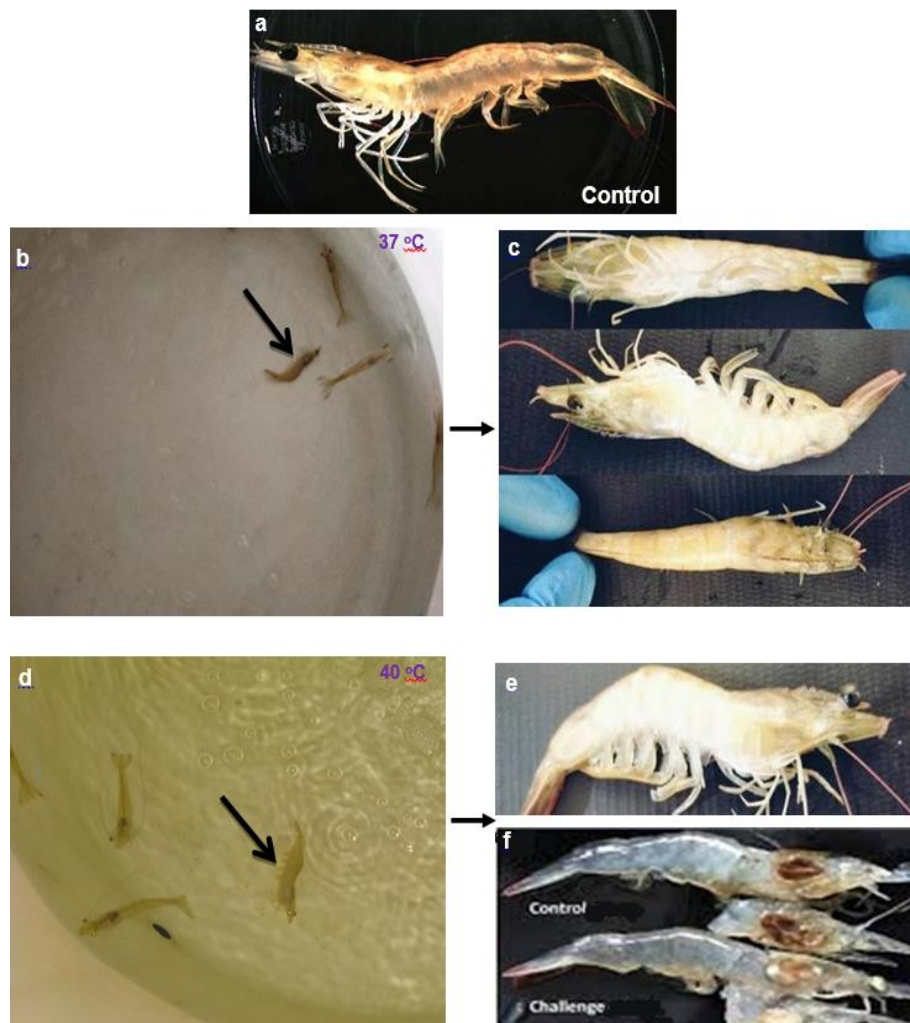

Particularly, severe problems can occur when climate change linked environmental extremes not only stress the host, but also favor the pathogen. Increases in temperature and salinity due to climate change are of particular concern in this regard. The modes of transmission and virulence of pathogens can also be influenced by climate change. It can be strongly argued that aquaculture

will witness alterations in the development, transmission and survival of pathogens and the susceptibility of their aquatic hosts. Environmental perturbations on account of climate change can significantly influence the disease process and might lead to increased disease outbreaks and spread of diseases to new geographical areas. Climate changes in temperature anomalies were assumed to have a significant impact on the health status and disease resistance of cultured animals. Variations in this parameter caused alterations in the several immunological tools used to evaluate the immune status of crustaceans as well as enhanced susceptibility of animals to pathogens. Centre for Ocean Research, Sathyabama Institute of Science and Technology has taken efforts to study the impact of temperature (sudden and gradual) on their growth and immunological changes and their mitigation measures using the development of functional feed. ICAR-National Innovations in Climate Resilient Agriculture, Government of India has sponsored this research grant (File No. 2-12(8)/CGC/16-17/NICRA) to support the SDG target 14.3.



3/8/2021 Duplicate CDR Print of Date: 3/8/2021

**PATENT OFFICE**  
**INTELLECTUAL PROPERTY BUILDING**  
 6.57, Block, Convent, Convent-400032  
 Tel: No. 91(02041) 2350081-84 Fax No. 044 23502066  
 E-mail: [Convent@iprbol.in](mailto:Convent@iprbol.in)  
 Web Site: [www.iprbol.in](http://www.iprbol.in)

GOVERNMENT OF INDIA

**INTELLECTUAL PROPERTY INDIA**  
 2005-2010  
 2010-2015  
 2015-2020

Date/Time : 08/03/2021 04:03:36  
 Agent Number:

**CHALLAN - TR-5**  
 DOCKET NO : 20331

To:  
 Dr. K. GOVINDARAJU  
 SCIENTIST C, CENTRE FOR OCEAN RESEARCH, SATHYABAMA INSTITUTE OF SCIENCE AND TECHNOLOGY,  
 RAJIV GANDHI SALAI, CHENNAI, TAMILNADU, INDIA 600119. govindaraju@gmail.com

Sr. No.	CBR No.	Reference Number / Application Type	Application Number	Title/Remarks	Amount Paid
1	9447	ORDINARY APPLICATION	202141009377	A METHOD FOR DEVELOPMENT OF HANDSCALE NUTRIENTS BASED SHRIMP FUNCTIONAL FEED FORMULATION	1750
2	E-10102810281-CHE		202141009377	Correspondence	0
3	E-27732021-CHE		202141009377	Form2	0
4	E-373162021-CHE		202141009377	Form3	0
5	E-51832021-CHE		202141009377	Form5	0
<b>Total :</b>					<b>1750</b>

Received a sum of Rs. 1750 (Rupees One Thousand Seven Hundred & Fifty only) through

Payment Mode	Bank Name	Cheque/Draft Number	Cheque/Draft Date	Amount in Rs
Draft	Indian Bank	348711	01/03/2021	1750

Note: This is electronically generated receipt hence no signature required.

Activate Wine

To minimize and address the impacts of ocean acidification and to support the SDG target 14.3, Centre for Climate Change Studies, Sathyabama Institute of Science and Technology jointly carried out with Center of Villa Dohrn Ischia – Benthic Ecology, Department of Integrative Marine Ecology, Stazione Zoologica Anton Dohrn, P.ta S. Pietro, Ischia, Naples, Italy, Department of Biology and Evolution of Marine Organisms, Stazione Zoologica Anton Dohrn, Villa Comunale, Naples, Italy, Department of Pharmacology and Toxicology, College of Pharmacy, King Saud University, Riyadh, 11451, Saudi Arabia, Bioproducts Research Chair,

Zoology Department, College of Science, King Saud University, Saudi Arabia, Botany and Microbiology Department, Faculty of Science, Beni-Suef University, Beni-Suef, Egypt,

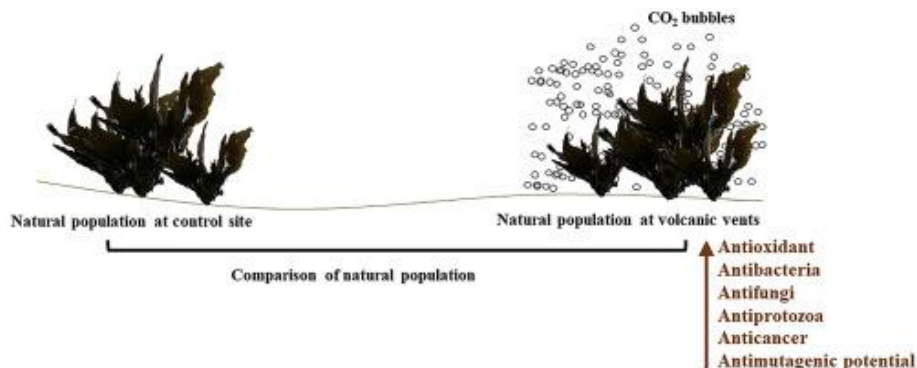

Integrated Molecular Plant Physiology Research Group (IMPRES) Department of Biology, Belgium to report the impact of ocean acidification to

support the Target 14.3.

The study utilized volcanic CO<sub>2</sub> vents at CastelloAragonese off Ischia Island as a natural laboratory to investigate the effect of lowered pH/elevated CO<sub>2</sub> on the bioactivities of extracts from fleshy brown algae *Sargassumvulgare* C. Agardh. They analysed the carbohydrate levels, antioxidant capacity, antibacterial, antifungal, antiprotozoal, anticancer properties and antimutagenic potential of the algae growing at the acidified site (pH ~ 6.7) and those of algae growing at the nearby control site LaccoAmeno (pH~8.1). The results of the present study show that the levels of polysaccharides fucoidan and alginate were higher in the algal population at acidified site. In a snapshot they performed bioactivity assays but did not characterize the chemistry and source of presumptive bioactive compounds. Nevertheless, the observed improvement in the medicinal properties of *S. vulgare* in the acidified oceans provides a promising basis for future marine drug discovery. The outcome of this work was published in Environmental Pollution journal (<https://doi.org/10.1016/j.envpol.2019.113765>)

#### Target 14.4. SUSTAINABLE FISHING

**(By 2020, effectively regulate harvesting and end overfishing, illegal, unreported and unregulated fishing and destructive fishing practices and implement science-based management plans, in order to restore fish stocks in the shortest time feasible, at least to levels that can produce maximum sustainable yield as determined by their biological characteristics)**

To address the overfishing, illegal, unreported and unregulated fishing in Target 14.4, a research project is being carried out Centre for Ocean Research, Sathyabama Institute of Science and Technology with the support of Ministry of Earth Sciences. Land based closed cycle culture of Indigenous sea urchin species and development of post-harvest protocols for preservation of roes has been addressed in this MOES project (Ref: MoES/36/OOIS/Extra/39/2014).

Echinoids aquaculture is being carried out as a commercial activity to harvest the gonads or roe which is a delicacy in Asian and Mediterranean countries. A sea urchins roe is being consumed by humans since pre-historic times in many countries around the world and are considered a high nutritional valuable food source. High exploitation rate has endangered this species in many countries that in turn created interest towards development of sea urchin larval

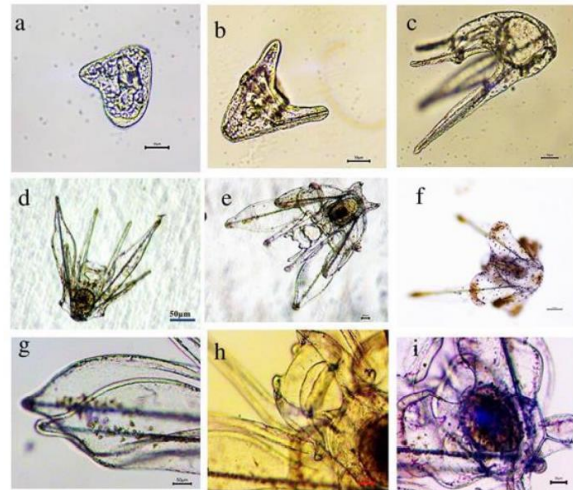

cultivation and rearing techniques. Development of sea urchin aquaculture has greatly advanced by the enhancement of ranching techniques, which directly targets gonadal growth and reproduction by nutritional enhancement. The outcome of the research grants supports the SUSTAINABLE FISHING and investigated the larval rearing, development, survival and growth rate of sea urchins, *Salmacis bicolor* fed with various microalgal diets under laboratory condition. Fertilization rate was estimated as 95%. The blastula and gastrula stages attained at 8.25 h and 23.10 h post-fertilization. The 4 - armed pluteus larvae were formed with two well - developed post-oral arms at 44.20 h following post-fertilization. The 8 - armed pluteus attained at 9 days post fertilization. The competent larva with complete rudiment growth was developed on 25th days post - fertilization. Monodiet algal feed - *Chaetoceros calcitrans* and *Dunaliella salina* resulted medium ( $50.6 \pm 2.7\%$ ) and low survival rate ( $36.8 \pm 1.7\%$ ) of *S. bicolor* larvae.

However, combination algal feed – *Isochrysis galbana* and *Chaetoceros calcitrans* has promoted high survival rate ( $68.3 \pm 2.5\%$ ) which was significantly different between the mono and combination diet. From the observations of the study, combination diet could be adopted as an effective feed measure to promote the production of nutritionally valuable roes of *S. bicolor*. The findings would immensely be helpful towards the development of induced breeding, commercial larval production for achieving high aquaculture potential of Temnopleuridae sea urchins under captive rearing condition. In future, development of sea urchin aquaculture will rely on positive interactions of commercial fisheries and aquaculturists towards mutual developmental activity for growth management and commercial production of larvae. As the market demand for sea urchin roes has been continuously increasing all over the globe, commercial culturing activities to enhance productivity needs to be addressed. This report will be highly beneficial to understand

the biological and environmental parameters required for successful culturing of other echinoids species. The outcome of this work was published in Iranian Journal of Fisheries Science (<https://doi.org/10.22092/ijfs.2020.122939>).

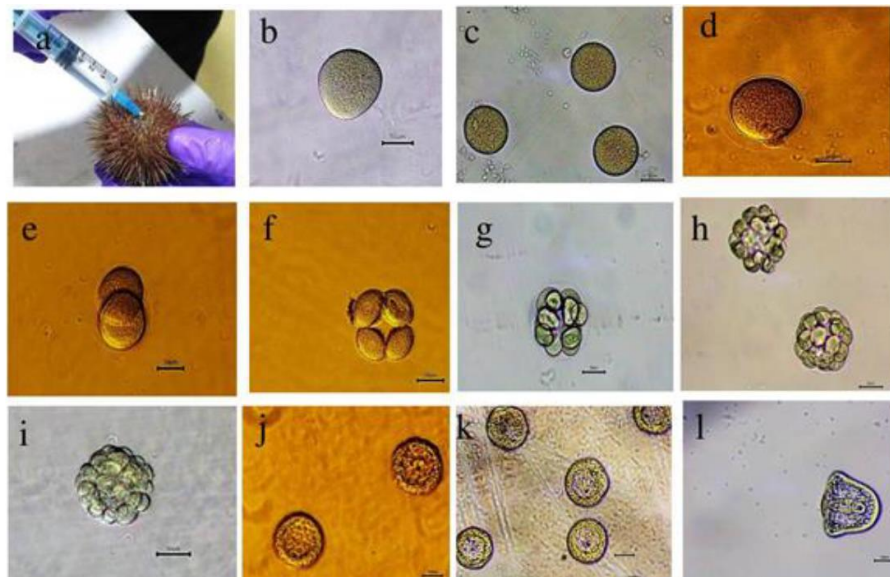

#### **Target 14.5. CONSERVE COASTAL AND MARINE AREAS**

**(By 2020, conserve at least 10 percent of coastal and marine areas, consistent with national and international law and based on the best available scientific information)**

Center for Ocean Research investigated the DNA Barcoding of marine polychaete worms from the south-east coast of India. This project is funded by the Ministry of Earth and Sciences (Project Reference MoES/36/00IS/Extra/5312016), Polychaetes occupy important positions in the food web, more particularly in the backwater ecosystem. In the present study an attempt was made to identify important polychaete collected from the Southeast coast backwater ecosystem.

The macrobenthic faunal samples were analyzed from Ennore creek, Pulicat lake, Muttukaadu (Kovalam) back water, Cooum estuary, Pondicherry mangroves, Uppanar estuary (Cuddalore), Vellar estuary (Parangipettai), Pazhayakalay estuary (Tuticorin), Karankadu mangrove (Ramanathpuram) and Thottavilam estuary (Kanyakumari). The seasonal occurrence with reference to water parameters was carried out. Totally 73 species were identified morphologically and among them 38 abundant species were sequenced using molecular tools 14 species of polychaete was identified during summer, 11 species during monsoon, and 12 species during winter at Ennore creek. A total of 19 species of polychaete belonging to different Genera were found in Ennore creek, out of which only 6 were identified at the molecular level. Similarly, 4 polychaete species were identified during summer, 4 species during monsoon, and 2 species during winter. Five species in total belonging to different Genera were identified, out of which 4 were identified till the molecular level in the Cooum estuary. In Muttukaadu back water, 4 species during summer, 4 species during monsoon, and 9 species during winter. Overall, 10 species were collected and 3 were identified at the molecular level. In Pulicat, 11 species were identified during summer, 15 species during monsoon, and 16 species during winter were identified morphologically. Totally 10 different polychaete species and 13 species already recorded from previous stations. Only 3 abundant species were sequenced. Four species were identified at the time of summer, 7 species were during monsoon, and 6 species were during winter at Vellar estuary (Parangipettai).

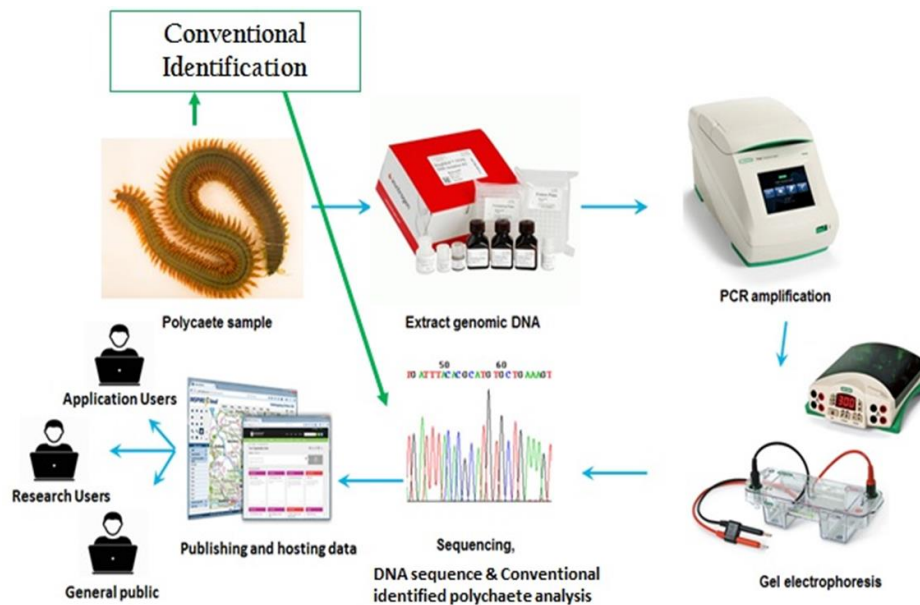

Fig. 1, DNA barcoding work flow



Out of 8 different species identified morphologically, two species were recorded in previous stations and molecular identification was done for 6 species. In the Uppanar estuary, 4 species in summer, 8 species in monsoon, and 6 species in winter were morphologically identified. Out of 9 species, 3 species were identified at the molecular level in the Uppanar estuary. 3 species during summer, 5 species during monsoon, and 6 species during winter were traditionally identified from the Pondicherry mangroves. 5 different species, 2 already recorded species were identified, and 3 species were sequences. We could observe 2 species during summer and 2 species during winter in the Pazhayakayal estuary. Totally 4 species were identified based on morphology and molecular tools. Similarly, 3 species during summer and 4 species during monsoon were identified morphologically in Karankadu mangroves. Total of 5 species were identified traditionally and using molecular methods. Totally 4 species were identified traditionally and using molecular tools in Thottavilam estuary. The output of this work will help to conserve at least 10 percent of coastal and marine areas, consistent with national and international law and based on the best available scientific information and to support the SDG target 14.4.

To conserve at least 10 percent of coastal and marine areas, consistent with national and international law and based on the best available scientific information and to support the SDG target 14.4, Centre for Climate Change Studies, Sathyabama Institute of Science and Technology exploring the sharks and rays of Gulf of Mannar and findings were reported as a publication. The ‘fine-spotted’ whipray *Himantura tulul* Borsa et al., 2013 has been documented for the first time in Indian waters. Till 2018, Dasyatids in India constitute only 0.004% of the total fish landing (<http://www.cmfri.org.in/2018>). In total, 22 species of dasyatids have been recorded in India, including 3 species of *Himantura* (Kizhakudan et al., 2018). However, the previous checklist on the chondrichthians has reported 7 species of *Himantura* (Akhilesh et al., 2014) in India which needs to be validated. The above difference in the recorded numbers of *Himantura* might be due to the taxonomic confusion of overlapping morphological characters that resulted in the complex species (Borsa et al., 2013). DNA barcoding of mitochondrial cytochrome oxidase subunit I (COI) gene has been effective in species identification of dasyatids. This was the first record of the ‘fine spotted whipray’ *Himantura tulul* (Myliobatoidei: Dasyatidae) in the Indian coastal

waters. The output was published in Journal of Applied Ichthyology (<https://doi.org/10.1111/jai.14060>).

To conserve at least 10 percent of coastal and marine areas, consistent with national and international law and based on the best available scientific information and to support the SDG target 14.4, Centre for Climate Change Studies, Sathyabama Institute of Science and Technology

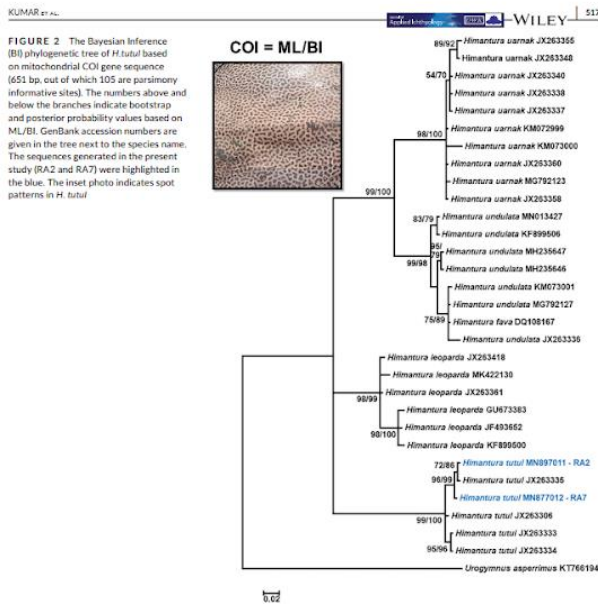

done the following work; Covelong coast situated in north Tamil Nadu has a unique habitat comprising intertidal rocky and sandy areas. Located near the mouth of Muttukadu brackish water, Covelong is considered as one of the sites for artificial reef deployment by the state government. With all these coastal habitats, it can be assumed that this area supports remarkably diverse marine life forms. The present work represents the first-of-its-kind study where we have assessed the

fish landing center, intertidal zones, and beach areas to assess the common marine and coastal diversity of Covelong. A total of 224 species of marine flora and fauna belonging to 135 families, 61 orders, 20 classes, and 10 phyla were reported from the fish landing center, intertidal rocks and sands, and beach strandings. The present findings will provide baseline information to marine enthusiasts, marine biologists, and ecologists for their future research on the Covelong

coast. We would recommend declaring the Covelong coast as one of the long-term monitoring sites for ecological studies, as this area is much influenced by natural



and anthropogenic activities. The output was published in *Regional Studies in Marine Science* (<https://doi.org/10.1016/j.rsma.2021.102034>).

To conserve at least 10 percent of coastal and marine areas, consistent with national and international law and based on the best available scientific information and to support the SDG target 14.4, Centre for Climate Change Studies, Sathyabama Institute of Science and Technology done a rare observation of sea anemone *Calliactis polyopus* on carapace of spider crab, *Doclea muricata* at the Covelong fish landing centre, Chennai, India and reported the occurrence in the



*Current Science* (<https://www.currentscience.ac.in/Volumes/121/07/0873.pdf>).

Population structure and reproductive performance in the sea anemone associated shrimp *Ancylorhis brevicarpalis* (Caridea: Palaemonidae) was studied by Centre for Climate Change Studies, Sathyabama Institute of Science and Technology, to conserve coastal and marine areas and provided scientific information to support the SDG target 14.4.

The peacock-tail shrimp *Ancylorhis brevicarpalis* Schenkel, 1902, is an obligate symbiont of sea anemones and well known for its remarkable colouration. Yet, very little information is available about its population structure and life-history traits, including reproductive parameters (fecundity, embryo volume and reproductive output). A total of 574 individuals were collected from the Gulf of Mannar, Tamil Nadu, India between February 2017



and July 2018, out of which 214 were males (37.28%), 355 were females (61.84%), and 5 (0.87%) juveniles. The highest percentage of individuals were observed in the post-monsoon season (38.10%) followed by monsoon (34.85%), pre-monsoon (15.02%), and summer seasons (12.01%). The overall sex ratio was skewed towards female individuals (0.55 male: 1 female). Fecundity was higher in females carrying early-stage embryos and embryo volume did increase, but not statistically significantly from early to late stages. The reproductive output was negatively allometric to the mean female body weight. The study provided first-of-its-kind information on the population as well as individual-level reproductive characteristics of *A. brevicarpalis* and reported in Journal of the Marine Biological Association of the United Kingdom (<https://doi.org/10.1017/S002531542000137X>).

To conserve at least 10 percent of coastal and marine areas, consistent with national and international law and based on the best available scientific information and to support the SDG target 14.4, an Online Short

Term Course On Adaptation Of Aquatic Systems To Climate Change (Reducing The Impacts And Maximizing Opportunities) jointly organized by Centre for Ocean Research, Sathyabama Institute of Science and Technology and Ministry of Earth Sciences- Earth Science and Technology

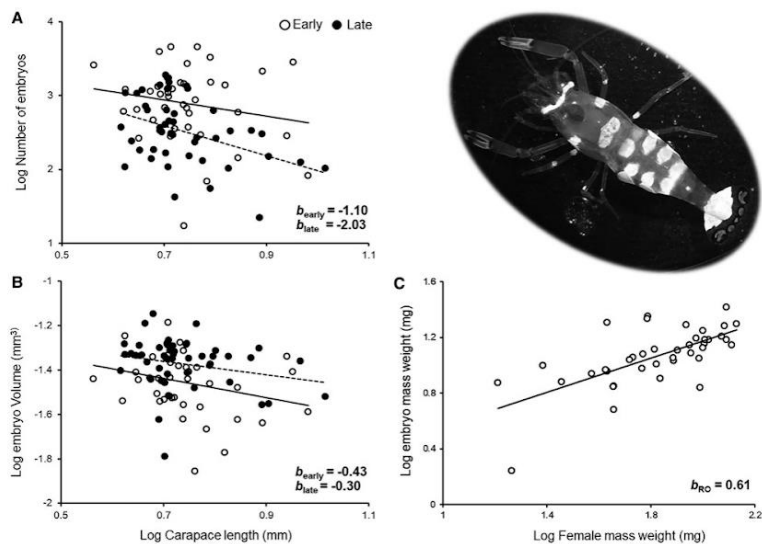

Cell.

<https://www.facebook.com/photo.php?fbid=3572310466156455&set=pb.100001326092623.-2207520000.&type=3>

Aquatic ecosystems are critical components of our nation and to the global environment. In addition to being essential contributors to biodiversity and ecological productivity, they also provide a variety of services for human populations, including water for drinking and irrigation, recreational opportunities, and habitat for economically important fisheries. However, aquatic systems have been increasingly threatened, directly and indirectly, by human activities. In addition to the challenges posed by land-use change, environmental pollution, and water diversion, aquatic systems are expected to soon begin experiencing the added stress of global climate change. Keeping these agenda as a backdrop this special 6 days online short term course was framed as per the objectives of Ministry of Earth Sciences- Earth Science and came to end. The following topics were presented in the course by experts:

1. Ecosystem-based approaches to adapt to climate change
2. Prospects of technological interventions
3. Reducing economic cost of adaptation
4. Sea level rise & Climate change
5. Climate Change and Science Communication
6. Adapting the communities and enhancing their livelihoods

Expert talks and links:

1. Dr E Vivekanandan, Expert Consultant, Central Marine Fisheries Research Institute - <https://www.youtube.com/watch?v=vu-md6LSstE&t=5675s>
2. Dr Grinson George, Senior Program Specialist – Fisheries, SAARC Agriculture Centre, Dhaka, Bangladesh - <https://www.youtube.com/watch?v=-H8npg65W9M>
3. Prof. Dr. S. Nagarathinam, Chairperson, Department of Communication, Madurai Kamaraj University - <https://www.youtube.com/watch?v=JPDjGtasNv4>
4. Dr Shyam Salim, Principal Scientist, Central Marine Fisheries Research Institute - <https://www.youtube.com/watch?v=ahTXhq5X928>

**SATHYABAMA**  
INSTITUTE OF SCIENCE AND TECHNOLOGY  
Approved by AICTE

**6 DAYS ONLINE SHORT TERM COURSE ON  
ADAPTATION OF AQUATIC SYSTEMS TO CLIMATE CHANGE:  
REDUCING THE IMPACTS AND MAXIMIZING OPPORTUNITIES**  
Dates: 2<sup>nd</sup> to 7<sup>th</sup> November 2020 06.00 - 07.00 PM

Listen and Interact with Experts from your Home!

<b>Ecosystem-based approaches to adapt to climate change</b> Dr. E. Vivekanandan National Consultant Central Marine Fisheries Research Institute Date: 2 <sup>nd</sup> Nov 2020   Time: 06.00 PM	<b>Prospects of technological interventions</b> Dr. Shyam Salim Principal Scientist Central Marine Fisheries Research Institute Date: 3 <sup>rd</sup> Nov 2020   Time: 06.00 PM (IST)
<b>Reducing economic cost of adaptation</b> Dr. Grinson George Senior Program Specialist SAARC Agriculture Centre, Dhaka Date: 4 <sup>th</sup> Nov 2020   Time: 06.00 PM	<b>Sea level rise &amp; Climate change</b> Dr. S. Nagarathinam Chairperson Department of Communication Madurai Kamaraj University Date: 5 <sup>th</sup> Nov 2020   Time: 06.00 PM
<b>Climate Change and Science Communication</b> Prof. Dr. S. Nagarathinam Chairperson Department of Communication Madurai Kamaraj University Date: 6 <sup>th</sup> Nov 2020   Time: 06.00 PM	<b>Adapting the communities and enhancing their livelihoods</b> Dr. Shyam Salim Principal Scientist Central Marine Fisheries Research Institute Date: 7 <sup>th</sup> Nov 2020   Time: 06.00 PM

**Patrons:**  
Dr. Manojkumar Johnson, Chancellor  
Dr. Manoj Johnson, President  
Dr. T. Sangeetha, Vice Chancellor

**Chair Person & Organizing Secretary:**  
Dr. E. Vivekanandan  
National Consultant  
Central Marine Fisheries Research Institute

**Programme Coordinator:**  
Dr. E. Vivekanandan  
National Consultant  
Central Marine Fisheries Research Institute

**Registration Fee: Rs. 500/- (India) / US\$ 20 (Others)**  
(E-Certificate will be given for the successfully completed participants)  
Last Date for Registration: 30/10/2020

**For Registration:**  
<https://link-google.com/forms/g?fbclid=IwAR1j0L8FFj0n859cE8V7j25Lqy48F1c4487nc2M6242cC6t>  
US\$100/verform?gclid=IwAR1j0L8FFj0n859cE8V7j25Lqy48F1c4487nc2M6242cC6t

**Target audience for the course:**  
Students, Research Scholars, Faculty, Policy Makers, Environmentalists, Science Communicators, Interest holders

This course is developed as per the objectives of Ministry of Earth Sciences (MoES), DST, and the certificate will be awarded by Centre for Ocean Research and Ministry of Earth Sciences, MoES.

**ORGANIZED BY**  
COL DR. VEPPANAR RESEARCH PARK  
CENTRE FOR OCEAN RESEARCH  
IN ASSOCIATION WITH  
EARTH SCIENCE AND TECHNOLOGY CELL,  
MINISTRY OF EARTH SCIENCES

Ministry of Earth Sciences  
Government of India

5. Dr. A. Saleem Khan, Dept of Humanities & Social Sciences, Indian Institute of Technology Madras - [https://www.youtube.com/watch?v=8nf\\_H8Q\\_2PQ](https://www.youtube.com/watch?v=8nf_H8Q_2PQ)
6. Dr. S. Velvizhi, Principal Scientist, MS Swaminathan Research Foundation - <https://www.youtube.com/watch?v=Q2GMX4q3w-o>

## Target 14.6 .END SUBSIDIES CONTRIBUTING TO OVERFISHING

**(By 2020, prohibit certain forms of fisheries subsidies which contribute to overcapacity and overfishing, eliminate subsidies that contribute to illegal, unreported and unregulated fishing and refrain from introducing new such subsidies, recognizing that appropriate and effective special and differential treatment for developing and least developed countries should be an integral part of the World Trade Organization fisheries subsidies negotiation)**

To prohibit certain forms of fisheries subsidies which contribute to overcapacity and overfishing, eliminate subsidies that contribute to illegal, unreported and unregulated fishing and to address the SDG target 14.5, an online quiz program was organized to engage the students and public from home during the lock down, Center for Ocean Research, Sathyabama Institute of Science and Technology, Chennai, India planned “ONLINE QUIZ SERIES” to celebrate “WORLD OCEANS DAY” on 8th June 2020 through the Earth Science & Technology Cell, Ministry of Earth Sciences.

**SATHYABAMA**  
INSTITUTE OF SCIENCE AND TECHNOLOGY  
(DEEMED TO BE UNIVERSITY)  
Accredited with Grade "A" by SAAC  
Jyppaar Nagar, Rajiv Gandhi Salai, Chennai - 600 119, Tamil Nadu, India.

**CENTRE FOR OCEAN RESEARCH**  
GOL. DR. JEPPIAAR RESEARCH PARK

**EARTH SCIENCE & TECHNOLOGY CELL**  
MINISTRY OF EARTH SCIENCES

In association with

**WELCOME TO THE ONLINE QUIZ SERIES AND TO CELEBRATE**  
**WORLD OCEANS DAY - 8<sup>th</sup> JUNE 2020**

<p>Topic : <b>MARINE BIODIVERSITY</b> Link : <a href="https://forms.gle/6UQJg8SLDvEWG4X8">https://forms.gle/6UQJg8SLDvEWG4X8</a> Organizers : <b>Ms. Anjali Das C G &amp; Ms. Mirunalini G</b></p>
<p>Topic : <b>MARINE CONSERVATION</b> Link : <a href="https://forms.gle/Y14FFqPcAwuDP7Ez6">https://forms.gle/Y14FFqPcAwuDP7Ez6</a> Organizers : <b>Ms. Anu C &amp; Mr. Sakthi Narendoran</b></p>
<p>Topic : <b>MARINE FISHERIES</b> Link : <a href="https://forms.gle/Ua2zWmpSb9FVzq57">https://forms.gle/Ua2zWmpSb9FVzq57</a> Organizers : <b>Mrs. S. Amreen Nisa, Mrs. D. Vinu, &amp; Mrs. Jyotsna</b></p>
<p>Topic : <b>MARINE POLLUTION</b> Link : <a href="https://forms.gle/uvE81BcGDVdJQjBo6">https://forms.gle/uvE81BcGDVdJQjBo6</a> Organizers : <b>Ms. Namitha R, Mr. Ajit Antony &amp; Mrs. Subhashini B</b></p>
<p>Topic : <b>AQUACULTURE</b> Link : <a href="https://forms.gle/mcZpYkpMjWjoub47">https://forms.gle/mcZpYkpMjWjoub47</a> Organizers : <b>Ms. Sowmya P &amp; Mr. Vineth Kumar C M</b></p>

**E-Certificates will be issued to all the participants who score above 60%**

Organizing Secretary  
**Dr. B. SHEELA RANI** - Director (Research)  
Convener  
**Dr. D. INBAKANDAN**, Head, Centre for Ocean Research  
For further details contact - **Mr. Vineth Kumar C M @ 9400670587**

This online quiz event was architected in such a way to showcase the major subject areas related to the Oceans like MARINE BIODIVERSITY, MARINE CONSERVATION, MARINE FISHERIES, MARINE POLLUTION and AQUACULTURE for the benefit of the faculties and student communities as a virtual programme during this pandemic situation. The research scholars from Center for Ocean Research together designed and organized this quiz series to celebrate this day. E-CERTIFICATES were issued to all participants who scored above 60% for each subject area. The quiz link was active from 8th to 12th June 2020.

Google form link: Marine Biodiversity: <https://forms.gle/HU6bNBdENd77R5mi8>

Marine Conservation: <https://forms.gle/Yt4FFqPcAwuDP7Ez6>

Marine Fisheries: <https://forms.gle/FRwk2xm2LAPTTQ3e7>

Marine Pollution: <https://forms.gle/uvE81BcGDVdJQjBo6>

Aquaculture: <https://forms.gle/mcZpeYykpMWjeub47>

<https://www.facebook.com/photo?fbid=3152094271511412&set=a.290295321024669>

To enhance the public conservation awareness on illegal fishing as per the Target 14.5, Centre for Ocean Research, Sathyabama Institute of Science and Technology in association with the Ministry of Earth Sciences jointly organized the "VIRTUAL SYMPOSIUM ON THE RECENT TRENDS IN AQUACULTURE INDUSTRIES" from 20th to 25th July 2020. As Col. Dr. Jeppiaar Research Park, Centre for Ocean Research is recognized as the nodal cell for Marine Biotechnological Studies, Ministry established the Earth Science and Technology Cell (ESTC) at Sathyabama Campus from 2019. Through the ESTC, a 6 days virtual symposium is organized to meet the top aquaculture industrial experts from all around the world using an online platform. The symposium was inaugurated by Dr. Gopal Iyengar, Scientist-G, Head - ESTC Program, Ministry of Earth Sciences, Government of India and by Prof. Dr. T. Balasubramanian, Vice-Chancellor, Chettinad Academy of Research & Education in the gracious presence of Vice-Chancellor, Dr. T. Sasipraba and Director (Research), Dr. B. Sheela Rani, Sathyabama Institute of Science and Technology. Dr. Gopal Iyengar, MoES appreciated the progress of Sathyabama-ESTC, as this virtual symposium is organized based on the objectives of NITI Aayog and Make in India policies. He also coined that this virtual program was a bridge for young entrepreneurs to meet the field level global aquaculture industrial experts from their home. MoES also advises Centre for Ocean Research to conduct such industrial linkage programmes jointly with Sathyabama - Technology Business

**LINKS FOR THE VIRTUAL SYMPOSIUM ON  
THE RECENT TRENDS IN AQUACULTURE  
INDUSTRIES**

(6 Days Program: 20<sup>th</sup> to 25<sup>th</sup> July 2020)

JOINTLY ORGANIZED BY  
**COL. DR. JEPPIAAR RESEARCH PARK**  
CENTRE FOR OCEAN RESEARCH (COR) &  
SATHYABAMA UNIVERSITY-TECHNOLOGY BUSINESS INCUBATOR (SU-TBI)  
in association with  
MINISTRY OF EARTH SCIENCES - EARTH SCIENCE & TECHNOLOGY CELL  
(ESTC)

<b>Recent advances in Aquaculture technologies &amp; super intensive system sustainable aquaculture</b> Dr. FARSHAD SHISHCHIAN Group President & CEO Blue Aqua Group, Singapore <a href="https://youtu.be/EXIGPP54Vg0">https://youtu.be/EXIGPP54Vg0</a>	<b>Ornamental Aquaculture Industry in India - After 2010 (latest trends and market)</b> Mr. R. SUNDARAJAN Madurai District Ornamental Fish Cooperative Society Ltd., Proprietor, Filial Aquatics, India <a href="https://youtu.be/ebkxvnc5MLY">https://youtu.be/ebkxvnc5MLY</a>	
<b>Shrimp Farming in India: What's next?</b> Dr. MANOJ M SHARMA Director Meyank Aquaculture Private Limited, India <a href="https://youtu.be/VgKBu2GxY4">https://youtu.be/VgKBu2GxY4</a>	<b>Shrimp Viral Diseases</b> Dr. AMERNENI RAVI KUMAR Director Alpha Biological, India <a href="https://youtu.be/xPTjVpAP4g">https://youtu.be/xPTjVpAP4g</a>	<b>Minimizing Production Cost for Sustainable Shrimp Farming</b> Mr. R. RAVIKUMAR Technical General Manager Growel Feeds Pvt. Ltd. in India <a href="https://youtu.be/05ccyq7M">https://youtu.be/05ccyq7M</a>
<b>Role of technology in making aquaculture ecosystem resilient - 3RPPM model</b> Mr. RAJAMANOHAR CEO & Co-Founder Aquaconnect, India <a href="https://youtu.be/9KZb0qVMY">https://youtu.be/9KZb0qVMY</a>	<b>Probiotics - The way to Sustainable Aquaculture</b> Dr. V. KATHIRAVAN Artis Animal Health Care (I) Pvt Ltd, India <a href="https://youtu.be/L3POJW2uQ">https://youtu.be/L3POJW2uQ</a>	<b>Current scenario of global seaweeds: prospects of commercial seaweed cultivation</b> Dr. MUTHUSWAMY JAIKUMAR Scientist, Sea6 Energy Pvt. Ltd., India <a href="https://youtu.be/4ev4Vp_0M0">https://youtu.be/4ev4Vp_0M0</a>
<b>Advanced Technologies in Aquaculture</b> Dr. P. E. CHERIAN Super Shrimps - Consultant Shrimp Hatchery Operator, India <a href="https://youtu.be/0XpdRp7ZDWk">https://youtu.be/0XpdRp7ZDWk</a>	<b>Advances in Aquaculture Nutrition Research</b> Dr. A. VICTOR SURESH Managing Director United Research (Singapore) Pte. Ltd. <a href="https://youtu.be/8d3e3LjvF8">https://youtu.be/8d3e3LjvF8</a>	<b>Aquaculture - Career and Opportunities</b> Dr. MARIYARAJ VIJAY Director, Best Aquacult Shrimp Hatcheries Proprietor, Arcamoo Life Sciences <a href="https://youtu.be/4d4CYDz_GA">https://youtu.be/4d4CYDz_GA</a>
<b>Lab to land technology: Large scale outdoor mass cultivation of microalgae for shrimp aquaculture</b> Dr. P. SELVAKUMAR Scientist, BMR Industries Pvt. Ltd., India <a href="https://youtu.be/00YV8DzIQ">https://youtu.be/00YV8DzIQ</a>	<b>Listen to the Aquaculture Industrial Experts from your Home!</b> <b>INAUGURAL SESSION</b> <a href="https://youtu.be/vdLsGsFzwFs">https://youtu.be/vdLsGsFzwFs</a> <b>VALEDICTORY SESSION</b> <a href="https://youtu.be/vF-KxUq3eV0">https://youtu.be/vF-KxUq3eV0</a> <a href="http://www.centreforocceanresearch.in">www.centreforocceanresearch.in</a>	

Incubator in future. Around 2131 registered participants from 25 different countries around the world were benefited from this virtual symposium.

The objective of Centre for Ocean Research in association with MoES-ESTC is to develop a common platform and create linkages with agencies institutes, industries on state, National and International levels for collaborative thoughts and disseminate the ideas on the augmentation of marine biological resources. The major goal of the symposium was focused towards aquaculture industries. As aquaculture and allied research is one of the focused are of Centre for Ocean Research, this virtual symposium was designed as per the objective of MoES and Centre for Ocean Research. This virtual symposium was famed for 6 days and planned for two sessions on each day- one in the morning by 10:00 am and in the noon by 1:00 pm. For the invited talks, field level and pioneer speaker in aquaculture industries were invited. She also welcomes the pioneer speakers in the field of aquaculture who accepted our invitation to deliver a talk in this virtual symposium. The guest speakers were as follows

Dr. FARSHAD SHISHEHCHIAN, Group President & CEO, Blue Aqua Group, Singapore. Mr. R. SUNDARARAJAN, Madurai District Ornamental Fish Cooperative Society Ltd., Proprietor, Filial Aquatics, India. Dr MANOJ M SHARMA, Director, Mayank Aquaculture Private Limited, India. Dr. AMERNENI RAVI KUMAR, Director, Alpha Biological, India. Mr. RAJAMANO HAR CEO & Co-Founder Aquaconnect, India. Mr. B. RAVIKUMAR, Technical General Manager Growel Feeds Pvt. Ltd. in India. Dr. P. E. CHERAN, Super Shrimps - Consultant Shrimp Hatchery Operator, India. Dr. V. KATHIRAVAN, Artis Animal Health Care (I) Pvt Ltd, India. Dr. A. VICTOR SURESH, Managing Director, United Research (Singapore) Pte. Ltd. Dr. MUTHUSWAMY JAIKUMAR, Scientist, Sea6 Energy Pvt. Ltd, India. Dr. P. SELVAKUMAR, Scientist, BMR Industries Pvt. Ltd., India. Dr. MARIYARAJ VIJAY, Director, Best Aquastar Shrimp Hatcheries Proprietor, Arcanoe Life Sciences. She conveyed that for the program 950 registrations were received from several Countries such as India, Bangladesh, Oman, Qatar, Singapore,

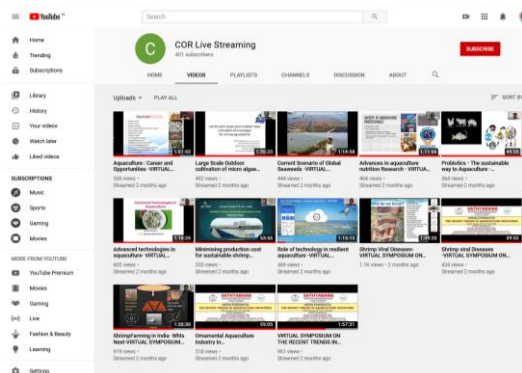



Indonesia, Malaysia, Spain, SriLanka, Republic of Maldives and UAE. The entire event information is available online, like INAUGURAL SESSION <https://youtu.be/vdLsGsFzwFs/> VALEDICTORY SESSION <https://youtu.be/yF-KxUq3oV0> and in <https://www.youtube.com/channel/UCNQ3ByrTjF0jLbMSBVRzRjA/videos>

**RECOMMENDATIONS SUBMITTED TO MINISTRY OF EARTH SCIENCES,  
GOVERNMENT OF INDIA BASED ON THE VIRTUAL SYMPOSIUM ON  
THE RECENT TRENDS IN AQUACULTURE INDUSTRIES**

<b>Committee Members</b>	<b>Final Recommendations</b>
Dr. B. Sheela Rani Director – Research Program Coordinator, MoES- ESTC Sathyabama Institute of Science and Technology	Academia – Industry – Farmers meet and collaboration should be strengthened for effective and innovative aquaculture out puts through the MoES-ESTC and Sathyabama TBI.
Dr. T. Sasipraba Vice-Chancellor Sathyabama Institute of Science and Technology	Young entrepreneurs to start their ownership in the field of aquaculture. Supply of quality (equal to export quality) aquaculture food is in demand in domestic market. So, in the make in India concept, young entrepreneurs should utilize the experience of scientists, field experts to develop strategic plans for utilizing the new ideas and trends in aquaculture to meet the demands of the local market.
Prof. Dr. T. Balasubramanian Vice Chancellor, Chettinad Academy of Research & Education, Member - SSC-MEB	Sathyabama should take initiative to popularize the marine food resources for consumption, storage and trade. Possibility of augmentation of industries from the blue economy could be achieved. Marine Bio resources should be focused towards conservations, sea ranching and the impact of climate change from market to tropical regions for uninterrupted supply of safe and healthy seafood to the community.
Dr. Gopal Iyengar Scientist – G, HEAD, MoES- ESTC Program, Member Convener	Aquaculture is the chief stage to bridge the gap of production and biotechnological inventions for sustainable developments. Technical inventions should be promoted for the proliferation of marine bioresources. State-of-the-art development should not decline any fisheries resources and pave the way for suitability. Promotion of climate smart technology and adverse impact of global environmental change must be studied. Comprehensive infrastructure development in the commercialization of aqua hatcheries, health management and feed supply should be encouraged. ESTC cell is now moving to support theme based research. Appreciated the good work done by ESTC at SIST. At last he said make in India and Atmanirbhar Bharat should be considered for better society.

Prof. Dr. Dileep N. Deobagkar Former Vice Chancellor Goa University Chairman - SSC- MEB	Increase of productive through intervention is required to support the protein supplements. Fisheries sector has more links than other industries as it is involved in many socially and economically important entrepreneurships. Fresh water aquaculture system is most supportive whereas marine aquaculture system is lacking as the focus were different. The products should be available to the mass of people by increasing the productivity and maintaining the quality. Focus on all species of aquaculture system and diversify the products, new hatcheries and new species in blue economy.
Dr. Jagvir Singh Scientist –F, Coordinator, MoES-ESTC Program, Member Convener	Blue revolution should be taken into consideration and expansion of expertise in the field of marine science is required. New ideas and new thoughts to be involved under the Atmanirbhar Bharat scheme.
Dr. R. Kirubakaran Former Scientist G & Head, MBT, NIOT, Member - SSC- MEB	He said that aquaculture problem is associated with three major issues: Seed production, Fish formulation and Disease management. New Technology should be developed towards native species so that other countries could not compete and solve problems associated with aquaculture and our Country.
Dr. Loka Bharathi Pa Former Emeritus Scientist, CSIR-NIO, Member - SSC- MEB	Aquaculture disease must be addressed and efforts to minimize the outbreaks should be discussed. Algal blooms-eutrophication should be avoided and addressed. Make use of technologies to turn Vain into boon. Make use of this disease forming algae to develop some good aspects to stop pollution.
Dr. Farshad Shishehchian Group President & CEO Blue Aqua Group, Singapore	AI, Automation and IoT concepts are concentrated in Blue Aqua Singapore farms and the same can be recommended in Indian Aquaculture field to increase the production and for good farming practice.
Dr Manoj M Sharma Director Mayank Aquaculture Private Limited, India	Eco friendly aquaculture practice should be followed in India and Government should recommend on green cultivation and effective effluent recirculatory practices. Domestic demand for quality shrimp should be promoted with local outlets. High tech outlets for seafood like “Zingalala” concept are promoted in all states.
Mr. Rajamanohar CEO & Co-Founder Aquaconnect, India	Aquaconnect, a farm advisor mobile app for shrimp farmers to improve the farm productivity and traceability was developed by him. This tool helps them to manage the Pond water quality, Feeding information, Growth rate in one place rather than keeping them in multiple farm ledgers this app uses machine learning technology to provide insights to the farmers and suggests appropriate advice for better productivity and disease predictability.
Dr. P. E. Cheran	Highlighted the importance of advance technologies like

Super Shrimps - Consultant Shrimp Hatchery Operator, India	Biofloc, Recirculatory Aquaculture Systems (RAS) and Integrated multi-trophic aquaculture (IMTA) and insisted Ministry to promote the same through ESCT with Sathyabama TBI.
Dr. A. Victor Suresh Managing Director United Research (Singapore) Pte. Ltd.	Supply for quality formulated feed with best FCR is the major demand in aquaculture industries. Researches on ecofriendly pellet feed are always having a huge demand in market. Still pellet feed for other aquatic species are only in the stage of infancy and that have to be promoted by Government. Incubation centers for developing new pellet feed
Dr. P. Selvakumar Scientist, BMR Industries Pvt. Ltd. , India	Marine micro algal biotechnologies have to be strengthened with high end cum climate adaptive technology for the augmentation of micro algal byproducts.
Mr. R. Sundararajan Madurai District Ornamental Fish Cooperative Society Ltd., Proprietor, Filial Aquatics, India	Ornamental fish trade and have to be prioritized and MoES-ESTC through Sathyabama TBI should provide training and develop young entrepreneurs.
Dr. Amerneni Ravi Kumar Director Alpha biological, India	MoES-ESTC and Sathyabama TBI should support and establish more number of aqua-clinics at the reach of each aquaculture farms. Funding support to establish farmer friendly or approachable disease diagnosis labs should be encouraged by Government to trouble shoot the diseases management in shrimp farming industries in India.
Mr. B. Ravikumar Technical General Manager Growel Feeds Pvt. Ltd. in India	Even though we have technologies and industries for production of adequate feed and seed for the Shrimp Aquaculture Industries, we have to concentrate on introduction of new species to culture which directly depends on the production of new feed for the candidate species of introduction.
Dr. V. Kathiravan Artis Animal Health Care (I) Pvt Ltd, India	Recent days, usage of probiotics in shrimp industries helps in higher production in aquaculture. Ecofriendly approaches with higher production are a success key for any production cycle as the entire globe is focusing on sustainability. An initiative on such new probiotics products is needed for future.
Dr. Muthuswamy Jaikumar Scientist, Sea6 Energy Pvt. Ltd. , India	The potential of India's largest coastal area have to be explored more and seaweed cultivation will be the best for climate friendly food source in future. Indigenous seaweed species are not explored potentially and government should focus and strengthen such initiatives through women entrepreneurs and self help groups.
Dr. Mariyaraj Vijay Director, Best Aquastar Shrimp Hatcheries Proprietor, Arcanoe Life Sciences	More women entrepreneurs should be encouraged in aquaculture industries. Sathyabama MoES ESTC should provide more opportunity to women researchers and entrepreneurs.

## Target 14.7. INCREASE SCIENTIFIC KNOWLEDGE, RESEARCH AND TECHNOLOGY FOR OCEAN HEALTH

(Increase scientific knowledge, develop research capacity and transfer marine technology, taking into account the Intergovernmental Oceanographic Commission Criteria and Guidelines on the Transfer of Marine Technology, in order to improve ocean health and to enhance the contribution of marine biodiversity to the development of developing countries, in particular small island developing States and least developed countries)

Centre for Ocean Research, Sathyabama Institute of Science and Technology with the technical guidance under National Institute of Ocean Technology, to promote research and development towards the SDG 14 targets such as reduce marine pollution; protect and restore ecosystems; reduce ocean acidification; sustainable fishing; conserve coastal and marine areas; end subsidies contributing to overfishing; increase the economic benefits from sustainable use of marine resources; increase scientific knowledge; research and technology for ocean health; support small scale fishers; and implement and enforce international sea law. Based on the research infrastructure and publication growth, MoES, thoroughly investigated their proposal request and supported financially on the establishment on ESTC for Marine Biotechnological Studies and sanctioned with 5 major network research projects in collaboration with CMLRE and NIOT.



The Earth Science & Technology Cell (ESTC) for network projects on Marine Biotechnological Studies was inaugurated by Dr. M. Rajeevan, Secretary, MoES at Sathyabama

Institute of Science and Technology (SIST), Chennai on 11th October 2018. The objectives of the MoES-ESTC at Sathyabama Institute of Science and Technology is in agreement with the sustainable develop goals, such as to augment marine living resources and marine biotechnology in collaboration with Centre For Marine Living Resources & Ecology (CMLRE) & National Institute of Ocean Technology (NIOT); to identify the R&D requirements and to fulfill the gap to develop potent marine bioactive products; to establish collaboration between National and International Institutions; and to create infrastructure facilities related to advanced research in marine biotechnological studies. (Ref: MoES/11-MRDFIESTC-MEB(SU)/2/2014 PC-III),

INFRASTRUCTURE FACILITIES

LABORATORY FACILITIES

- ◆ Macro algal by-products lab
- ◆ Live feed culture lab
- ◆ Photo period lab
- ◆ Fish endocrinology lab
- ◆ Aquatic health lab
- ◆ Sewwater Recirculatory System
- ◆ Micro algal culture lab
- ◆ Sea urchin culture lab
- ◆ Fish genetics & breeding lab
- ◆ Sewwater treatment facility
- ◆ Fish pathology lab
- ◆ Technology Business Incubation
- ◆ Artemia by-products lab
- ◆ Bio-products lab
- ◆ Applied engineering lab
- ◆ IPR & Documentation
- ◆ Materials chemistry lab
- ◆ Post harvest technology lab
- ◆ Marine biotechnology lab
- ◆ Climate change research lab
- ◆ General analytical lab
- ◆ Marine ecotoxicology lab
- ◆ Marine biofouling lab
- ◆ Marine microbial technology lab
- ◆ Spectroscopy lab
- ◆ Mass spectroscopy lab
- ◆ Microscopy lab
- ◆ Proteomics & genomics lab
- ◆ Cell culture lab
- ◆ Bio-fermentation lab

<https://www.facebook.com/SathyabamaOfficial/posts/pfbid02ruLd8ERELG6pgD4cDX2GeXfe7vCYB16j9MH5FFa1jkTYd8Z9ZNgdvQ6ZuQVJyp4yl>

**SATHYABAMA**  
INSTITUTE OF SCIENCE AND TECHNOLOGY

---

EARTH SCIENCE AND TECHNOLOGY CELL  
(Marine Biotechnological Studies)

COL. DR. JEPPIAAR RESEARCH PARK  
Centre for Ocean Research  
(DST - FIST Sponsored Centre)

SUPPORTED BY  
MINISTRY OF EARTH SCIENCES (MOES)  
GOVERNMENT OF INDIA

---

**ABOUT SATHYABAMA - CENTRE FOR OCEAN RESEARCH - EARTH SCIENCE & TECHNOLOGY CELL.**  
The main purpose of Sathyabama - Centre for Ocean Research - ESTC is innovation and application of high end biotechnologies upon Marine Biosciences of Indian Coast for genetic characterisation, assessment, conservation bioprospecting of potent bioactive molecules for sustainable utilization, intellectual property rights, economic benefits and prosperity. The science plan of the present ESTC is to create adequate expertise in various disciplines of marine biotechnology studies for the benefit of the society for enhanced awareness about the phenomenon and progress of earth systems. Sathyabama - Centre for Ocean Research - ESTC for Marine Biotechnological Studies will encourage universities, colleges & institutes to perform their ranking research in marine science. It nurtures the benefits that our country could realize from her vast ocean regions. It generates scientific temper and awareness among the public and school children about ocean and its resources, scientific, management and development. It promotes proven/ viable technologies for harnessing of marine resources for the benefit of the local communities in the areas of aquaculture, seaweeds, fishing gear improvisation, etc.

---

**OBJECTIVES**

- To augment marine living resources and marine biotechnology in collaboration with CMLRE and NIOT
- To identify the R&D requirements and to fulfill the gap to develop potent marine bioactive products
- To establish collaboration between National and International Institutions.
- To create infrastructure facilities related to advanced research in marine biotechnological studies

---

**VISION**  
To realize the potential of Marine Biotechnology for safe marine environment and marine bio products, leading to overall socio-economic growth, welfare and progress of humanity

**MISSION**  
Proposed ESTC will generate, support and facilitate the research to realize the marine living resources to improve the quality of human resources interaction in biotechnology industries for societal applications

---

**INFRASTRUCTURE FACILITIES - CENTRE FOR OCEAN RESEARCH**

- ◆ Macro algal by-products lab
- ◆ Fish genetics & breeding lab
- ◆ Materials chemistry lab
- ◆ Spectroscopy lab
- ◆ Live feed culture lab
- ◆ Sea water treatment facility
- ◆ Post harvest technology lab
- ◆ Mass spectroscopy lab
- ◆ Microscopy lab
- ◆ Phytoplankton lab
- ◆ Fish pathology lab
- ◆ Marine biotechnology lab
- ◆ Marine ecotoxicology lab
- ◆ Climate change research lab
- ◆ Cell culture lab
- ◆ Aquatic health lab
- ◆ Artemia by products lab
- ◆ General analytical lab
- ◆ Cell culture lab
- ◆ Sewwater Recirculatory System
- ◆ Bio-products lab
- ◆ Marine ecotoxicology lab
- ◆ Marine biofouling lab
- ◆ Marine microbial technology lab
- ◆ Micro algal culture lab
- ◆ Applied engineering lab
- ◆ Marine biofouling lab
- ◆ Bio-fermentation lab
- ◆ Sea urchin culture lab
- ◆ IPR & Documentation
- ◆ Marine microbial technology lab

**SATHYABAMA**  
INSTITUTE OF SCIENCE AND TECHNOLOGY

---

**MANDATE**  
Sathyabama Institute of Science and Technology has a well established Centre for Ocean Research and is now interested to accelerate its activities at National & International level by collaborating with MOES through ESTC in the thrust areas of marine living resources. Sathyabama - Centre for Ocean Research - ESTC will nurture manpower to develop and disseminate advanced technology in the in the area of marine resources.

- To develop infra structure facilities for high end marine biotechnology based applications.
- To characterize the selected marine organisms for Molecular Taxonomy, phylogeny and genetic biodiversity.
- To develop a gene bank and a tissue repository for conservation of resources.
- To initiate bioprospecting programs of some marine species for potent bioactive molecules & compounds of therapeutic and industrial importance.
- To protect Intellectual Property Rights and to file patents.

---

Sanctioned activities for the next 3 years	Centre for Ocean Research Sathyabama Institute of Science and Technology	MOES NIOT & CMLRE
Project Coordinator: Dr. B. SHEELA RANI, Director (Research)	Principal Investigator	Project Collaborators
"Studies on the implications of engineered nanoparticles and bio-nanocomposites in aquatic animal health"	Dr. RADHIEA RAJASREE S.R.	Dr. R. KURUBAGARAN Dr. S. DHANAN ESOO-HOT, (FHEES) Chennai
"Surface modification nanotechnology approach for antifouling and anticorrosion applications"	Dr. D. INBAKANDAN	
"Enhancement of marine microbial by-products for biomedical applications"	Dr. L. STANLEY ABRAHAM	
"Biofunctionalization nanoparticles for anticancer applications using marine bioresources"	Dr. V. GANESH KUMAR	Dr. H. SARAVANAN ONLINE (FHEES) Coimbatore
"Isolation and identification of bioactive compounds from marine sponges for anti-herpetic syndrome (HESV) control"	Dr. K. GOVINDARAJU	

---

**EQUIPMENTS TO BE PROCURED IN ESTC**

- Stand alone rack - fish housing
- Digital microscope / tissue processor
- Cell counter
- Fluorescence microscope / image analyzer
- Impedance spectrophotometer
- Laminar flow
- Extraction vessels
- Incubator ovens
- Membrane filtration
- Ultra centrifuge
- Particle size analyzer
- Phase contrast microscope
- Hot air oven
- Microtome
- Biosafety cabinet
- EISA reader
- Confocal confituge
- Osmometer
- CO2 incubator

---

**For further details please contact:**  
Dr. B. SHEELA RANI  
Director (Research)  
Sathyabama Institute of Science and Technology  
Chennai - 600 119, Tamil Nadu, India.  
Email: directorresearch@sathyabama.ac.in / oceanresearch@gmail.com

The network project are (i) Studies on the implications of engineered nanoparticles and bio-nanocomposites in aquatic animal health, (ii) Surface modification nanotechnological approach for antifouling and anticorrosion applications, (iii) Enhancement of marine microbial by-products for biomedical applications, (iv) Biofunctionalization nanoparticles for anticancer applications using marine bioresources, and (v) Isolation and identification of bioactive compounds from marine sponges for white spot syndrome virus (WSSV) control. Research team of Centre for Ocean Research in association with CMLRE and NIOT worked on the projects to know the impact of nanoparticles in the marine environment and its tropical level transfer from primary, secondary to terrestrial and to the surrounding environment. Apart from ecotoxicological studies the team has also developed nano and natural product based coatings to combat the biofouling problem in marine environment especially to help shipping industries. The team has also extracted the bacterial pigments from the ocean and coastal microbial extremophiles and used the same for biomedical applications. Seaweed bioresources and its associated bacteria were explored and metabolites were extracted to produce nanomaterials for anticancer potential. The team were also worked on the sponge associated bacterial metabolites and worked on the solution to WSSV outbreak in shrimp aquaculture industries. Adding to the above the team was also contributed in the DNA barcoding of marine polychaetes and explored the possibilities for closed cycle indoor culture for the production of SPF marine polychaetes through the support of MoES. Sathyabama Institute of Science and Technology was established with a separate facility to showcase the MoES - Earth Science & Technology Cell (ESTC) to lift their research work to next level to the centre for excellence to gather the other institutes and universities at national and global level in network based approach to work on the thematic area, for the augmentation of marine bioresources and for their sustainable utilization.

Centre for Climate Change Studies (CCCS) at Sathyabama is also actively engaged in disseminating knowledge on marine and coastal biodiversity, conservation and climate change. We frequently organize workshops, training programs and symposiums in order to create awareness to the school and college students, teachers and public on the importance of biodiversity, conservation and climate change. We also collaborate with Tamil Nadu Science Forum to disseminate information in the local language for coastal communities including legal framework policies for marine and coastal conservation. Our events include:

1. Marine Biology Research Symposium
2. Field course on Marine Biology and Climate Change.
3. DNA Taxonomy and Phylogeny
4. Training of Trainers on Disaster Management
5. National Law Day
6. World Ocean Day
7. Clean Beach week
8. International Earth Day
9. Legal framework policy for marine conservation

**SATHYABAMA**  
INSTITUTE OF SCIENCE AND TECHNOLOGY  
(DEEMED TO BE UNIVERSITY)  
GATEWAY TO KNOWLEDGE

First National Virtual Event for Budding Marine Biology Enthusiasts  
**"MARINE BIOLOGY RESEARCH SYMPOSIUM" MBRS 2021**

Organized by  
CENTRE FOR CLIMATE CHANGE STUDIES  
in association with  
ICAR - NATIONAL BUREAU OF FISH GENETIC RESOURCES

LOCATION  
Lectures

DATES  
30<sup>th</sup> TO 31<sup>st</sup> JULY 2021

Registration Link: <https://forms.gle/9Znp703kay2w>

**SATHYABAMA**  
INSTITUTE OF SCIENCE AND TECHNOLOGY  
(DEEMED TO BE UNIVERSITY)  
GATEWAY TO KNOWLEDGE

Centre for Climate Change Studies  
We cordially invite you all to join us for  
**WORLD OCEAN DAY 2021**

Five Ecosystems and One User!

Event on 28<sup>th</sup> June 2021  
**Dr. Dattesh Desai**  
Principal Scientist  
National Institute of Oceanography  
Dona Paula, Goa.

Title: Marine Biofouling and Bioinvasion

Registration Link: <https://forms.gle/9Znp703kay2w>

Only registered participants will get the Zoom link for attending the lecture

DATE AND TIME  
08 June 2021 (Thursday)  
10:00 AM to 11:00 AM

CHIEF PATRONS  
Dr. Manjivra Johnson, Chancellor  
Dr. Mani Johnson, President  
Ms. Maria Bernadette Johnson, Vice President  
Dr. T. Sasipraba, Vice Chancellor

Co-organizers  
Dr. S. Prakash, Scientist - C  
Dr. Anil Kumar, Scientist - C  
Email: [training@satyabamait.ac.in](mailto:training@satyabamait.ac.in)

**SATHYABAMA**  
Institute of Science and Technology  
(Deemed to be university)  
Centre for Climate Change Studies

**National Clean Beach Week (July 1-7)**  
Webinar on the significance of clean beach

Date: 5 & 6 July 2021 Time: 10 to 11:30 AM

5<sup>th</sup> July  
Dr. Anil Kumar, Director - Terrestrial Marine Research, Topic: "Watershed and the FLOOD of 'WORLDWIDE'"  
Dr. Manjivra Johnson, Director - Terrestrial Marine Research, Topic: "Understanding our beaches and water: a local scientist's perspective"

6<sup>th</sup> July  
Dr. Vinodh Kumar, Regional Coordinator, Southern Beach Area, Topic: "Clean Beach: Challenge and solution"  
Capt. Dr. N. Thiruvanantharaman, Faculty, Dept. of Energy, Anna University, Chennai, Topic: "Understanding our beaches and water: a local scientist's perspective"

Co-organizers  
Dr. D. Ashwan  
Dr. S. Prakash  
Dr. Anil Kumar

PATRONS  
Dr. Manjivra Johnson, Chancellor  
Dr. Mani Johnson, President  
Ms. Maria Bernadette Johnson, Vice President  
Dr. T. Sasipraba, Vice Chancellor

**SATHYABAMA**  
Institute of Science and Technology  
(Deemed to be University)  
Centre for Climate Change Studies

Tamil Nadu Science Forum

Talk on Status of Coastal Community during COVID-19 pandemic season

Date: 28 June 2021 Time: 10 to 11:30 AM

Dr. D. Ashwan, Director - Terrestrial Marine Research, Topic: "Status of Coastal Community during COVID-19 pandemic season"

Co-organizers  
Dr. D. Ashwan  
Dr. S. Prakash  
Dr. Anil Kumar

**SATHYABAMA**  
INSTITUTE OF SCIENCE AND TECHNOLOGY  
(DEEMED TO BE UNIVERSITY)  
GATEWAY TO KNOWLEDGE

International Research Centre  
Centre for Climate Change Studies  
cordially invite you all to join for a webinar on  
**NATIONAL LAW DAY 2021**

Theme: Environmental Law and Policy

Date: 28 November 2021  
Time: 09:30 AM to 12:00 PM

CHIEF PATRONS  
Dr. Manjivra Johnson, Chancellor  
Dr. Mani Johnson, President  
Ms. Maria Bernadette Johnson, Vice President  
Dr. T. Sasipraba, Vice Chancellor

Co-organizers  
Dr. S. Prakash, Scientist  
Dr. Anil Kumar, Scientist

**SATHYABAMA**  
Institute of Science and Technology  
(Deemed to be University)  
Centre for Climate Change Studies

General speakers

09:30 AM - 10:00 AM  
Ms. Vaidhi Rajan, Senior Program Officer, Centre for Environmental Law, WWF, Topic: Introduction to Environmental Law and Policy

10:30 AM - 11:15 AM  
Mr. Srinivasan Jayaraman, Topic: Climate Change Vs. Land-use Change: Gaps in Law and Policy

11:30 AM - 12:00 PM  
Dr. Vinodh Kumar, Associate Professor, IIT Bombay, Topic: Environmental Issues in Andaman and Nicobar Islands and their impact on tribal communities

12:30 PM - 1:00 PM  
Ms. Smita Jha, Independent Lawyer, Topic: How to read Environmental Law

Registration Link:  
<https://forms.gle/9Znp703kay2w>

ZOOM Link will be sent only to registered participants

**SATHYABAMA**  
INSTITUTE OF SCIENCE AND TECHNOLOGY  
(DEEMED TO BE UNIVERSITY)  
GATEWAY TO KNOWLEDGE

Accredited "A" Grade by NAAC, ISO Certified by ISO 1, approved by AICTE

**Online course on DNA Taxonomy & Phylogeny**

A 6-week F-Post online course for beginners to learn about DNA taxonomy and phylogeny and its applications. The course includes video lectures on trending topics related to DNA taxonomy and phylogeny.

Topics to be covered:  
Theory, terms and concepts used in DNA taxonomy and phylogeny  
Identification, model, molecular markers, DNA barcoding, integrative taxonomy, metabarcoding, sequence analysis, environmental phylogenetic applications

Dr. D. Ashwan, Director - Terrestrial Marine Research, Topic: "Online course on DNA Taxonomy & Phylogeny"

Co-organizers  
Dr. D. Ashwan  
Dr. S. Prakash  
Dr. Anil Kumar

**SATHYABAMA**  
INSTITUTE OF SCIENCE AND TECHNOLOGY  
(DEEMED TO BE UNIVERSITY)  
GATEWAY TO KNOWLEDGE

Centre for Professional and Career Advancement  
Introducing a certificate course on  
**Marine Biology and Climate Change**

This hybrid certificate course (one of its kind in India) offers ~100 hours of rigorous training to learn marine biology and climate change. This course is about understanding marine life, marine industries, conservation, distribution patterns, adaptation strategies, along with focus on their evolutionary history. The participants will not only learn about the existing concepts, but will also develop innovative solutions to burning issues such as climate change in the marine environment.

Practical/Demon/Hands-on training  
Laboratory and survey using transects, quadrats, alve, and plankton net  
Water Quality  
Microbiological and molecular identification of common organisms  
Fish Landing visits  
Laboratory based experiments using gel electrophoresis and thermocycling

Duration: 2 months  
Online: 25<sup>th</sup> Jan - 15<sup>th</sup> Mar  
Field visit/Practical: 27<sup>th</sup> - 31<sup>st</sup> Mar

Dr. Manjivra Johnson, Chancellor  
Dr. Mani Johnson, President  
Ms. Maria Bernadette Johnson, Vice President  
Dr. T. Sasipraba, Vice Chancellor

**SATHYABAMA**  
Institute of Science and Technology  
(Deemed to be University)  
Centre for Climate Change Studies

Join us on  
**"International Earth Day"**

Guest speaker  
Forest Ranger Officer,  
Gulf of Mannar Biosphere Reserve, Tamil Nadu  
Recipient of IUCN-International Ranger Award, 2021  
Topic: Conservation of Marine Ecosystems: A Case Study from Gulf of Mannar and Palk Bay

Date and Time:  
22<sup>nd</sup> April 2021  
11 AM to 12 PM

Register here to receive ZOOM meeting details: <https://forms.gle/9Znp703kay2w>

Co-organizers  
Dr. D. Ashwan  
Dr. S. Prakash  
Dr. Anil Kumar

To address the SDG target 14.a. and to increase scientific knowledge, research and technology for ocean health, "Fast-Track Learning in Climate Change and Marine Life (CCML 2021)" was jointly offered by Center for Ocean Research, Sathyabama Institute of Science & Technology, Chennai in association with Earth Science and Technology Cell, Ministry of Earth Sciences (ESTC – MoES) and IUCN Commission on Ecosystem Management (IUCN – CEM) as a fast track course for the learner who want to know science of climate change and their impact on marine life and ecosystem. The course is specially designed by Dr. E. Vivekanandan,

**SATHYABAMA INSTITUTE OF SCIENCE AND TECHNOLOGY**  
National Webinar on  
**Legal framework for coastal and marine biodiversity conservation – An Indian perspective**  
27<sup>th</sup> to 29<sup>th</sup> July 2020  
Time: 6 to 7 PM

**Highlights of the webinar:**

- Coastal and marine biodiversity with special emphasis on ornamental trade
- Legal framework policy for the conservation of marine biodiversity in India
- Indian patent scenarios for the microorganisms and their products

**Guest speaker**  
Ms. P. M. VATSALA  
Advocate - Madras High Court  
Corporate & Legal Consultant

**Organizers**  
Dr. S. Prakash, Scientist C  
Dr. Amit Kumar, Scientist C  
Centre for Climate Change Studies

**PATRONS**  
DR. MARIJEENA JOHNSON  
CHANCELLOR  
DR. MARIE JOHNSON  
PRESIDENT  
DR. T. SASIPRABA  
VICE CHANCELLOR

For free registration: <https://forms.gle/uufaTA2r5KE9jn3U7>

Zoom ID will be shared only to registered participants. No separate emails will be sent. You are invited to join the Legal Framework google group upon registration.

E-certificates will be given to those who score more than 60% marks in the exit exam. Attendance is compulsory and you can also watch the lectures again in YOUTUBE. Up to 300 participants are allowed in the meeting room due to Zoom App limit. Others can join in the live streaming in YOUTUBE.

**SATHYABAMA INSTITUTE OF SCIENCE AND TECHNOLOGY**  
FAST-TRACK LEARNING IN CLIMATE CHANGE AND MARINE LIFE (CCML 2021)  
Date: June 12<sup>th</sup> & 19<sup>th</sup>, 2021 (2 days online course)  
MODE: SATHYABAMA INSTITUTE ONLINE PLATFORM

ORGANIZED BY  
CENTRE FOR OCEAN RESEARCH  
COL. DR. JEPPIAAR RESEARCH PARK

IN ASSOCIATION WITH  
EARTH SCIENCE AND TECHNOLOGY CELL,  
MINISTRY OF EARTH SCIENCES  
&  
COMMISSION ON ECOSYSTEM MANAGEMENT  
INTERNATIONAL UNION FOR CONSERVATION OF NATURE

**Speakers:**

- DR. E. VIVEKANANDAN, Former Principal Scientist, Central Marine Fisheries Research Institute,
- DR. P. KRISHNAN, Professor & Principal Scientist, National Academy of Agricultural Research and Management,
- DR. K. S. KAVIKUMAR, Professor, Madras School of Economics,
- DR. A. BIJU KUMAR, Professor & Head, Department of Aquatic Biology & Fisheries, University of Kerala
- DR. GRINSON GEORGE, Senior Programme Specialist, SAARC Agriculture Centre, Dhaka, Bangladesh,

National Consultant, Central Marine Fisheries Research Institute. The course is interactive, online and attendance is compulsory on both Saturdays, June 12th & 19th, 2021 (2 days online). The aim of the learning programme is to train the trainers of youth who are studying marine life. The programme is designed virtually on a fast-track mode for two days. Fast Track is an informal way of learning and it provides the quickest and most direct route to achievement of a goal. Fast track learning also saves time for the learners. It is a great opportunity to quickly

learn about the dynamics of global warming and climate change related issues with reference to marine life. Eminent field experts like (i) Dr. E Vivekanandan, Former Principal Scientist, Central Marine Fisheries Research Institute, (ii) Dr. P Krishnan, Professor & Principal Scientist, National Academy of Agricultural Research and Management, (iii) Dr K S Kavikumar, Professor, Madras School of Economics, (iv) Dr A Biju Kumar, Professor & Head, Department of Aquatic Biology & Fisheries, University of Kerala (v) Dr Grinson George, Senior Programme Specialist, SAARC Agriculture Centre, Dhaka, Bangladesh, were delivered their lecture to the National wide participants.

<https://www.youtube.com/watch?v=4Qu3COMj-tI>



<https://www.facebook.com/inbakandan/posts/pfbid0razZieAMe2pVHZnmayTfekEvvZ72fPCeUCWFqTKUEdijtAceYS1BJSZqToT9P6QSI>

[https://indiabioscience.org/events/fast-track-learning-in-climate-change-and-marine-life?fbclid=IwAR2rL-x5ITsw\\_dSJoIkuK9\\_oYI4NSUAwjtmP1ebMANtnNiiDiCy9NrQzw-M](https://indiabioscience.org/events/fast-track-learning-in-climate-change-and-marine-life?fbclid=IwAR2rL-x5ITsw_dSJoIkuK9_oYI4NSUAwjtmP1ebMANtnNiiDiCy9NrQzw-M)

Celebrate the World's Ocean Day 2021 with Center for Ocean Research, Sathyabama Institute of Science and Technology - Deemed to be University in association with Earth Science and Technology Cell, Ministry of Earth Sciences Government of India and join the online panel discussion on the theme – 'Coastal communities of Indian Ocean Region: Sustainability, Innovation and Livelihood'. Dr. Gopal Iyengar,

FAST-TRACK LEARNING IN CLIMATE CHANGE AND MARINE LIFE			
SYLLABUS AND SCHEDULE			
Time	Subject	Content	Resource Person
June 12, 2012 (Day 1) UNDERSTANDING CLIMATE CHANGE			
Session 0 0930 - 1015	Welcome	Opening remarks	SIST
Session 1 1015 - 1100	Basic Climate Change Science	Weather and climate, climate change and global warming; source of greenhouse gases, consequences of GHG concentration in the atmosphere and oceans Approach: One presentation; Q&A	Dr.E Vivekanandan
Session 2 1100 - 1200	Climate change scenarios	Changes in temperature in land and sea, rainfall, ice melting, sea level rise, pH, cyclones, etc Approach: One presentation; Q&A	Dr.Grinson George
Session 3 1200 - 1300	Responses to climate change	Two key response measures to deal with climate change, i.e., mitigation and adaptation Approach: One presentation; Q&A	Dr.Grinson George
<b>Break</b>			
Session 4 1400 - 1445	Key terminologies	Impacts, vulnerability, adaptation, mitigation, risk, hazards, shock, variability, trend, exposure, sensitivity, adaptive capacity etc. Approach: One presentation; Q&A	Dr.A Biju Kumar
Session 5 1445 - 1600	Impacts of climate change	Impacts on marine life Approach: One presentation; Q&A	Dr.E Vivekanandan
Session 6 1600 - 1715	Vulnerability to climate change	Concept of vulnerability, vulnerability to natural, physical and social system, how vulnerability varies within societies Approach: One presentation; Q&A	Dr.A Biju Kumar

Scientist-G & Programme Head – PAMC, Ministry of Earth Sciences, Government of India; Dr. Vivekanandan, Nation, I Consultant, ICAR-Central Marine Fisheries Research Institute; Dr. Adam Schlenger, Science Director, Innovation 4.4, Ocean Funders, USA; Dr. G. Dharani, Scientist -F & Group Head – MBT, MoES - National Institute of Ocean Technology; Ms. Sara Jolena Wolcott, Director, Sequoia Samanvaya, USA; Mr. Ramasubramanian, Sustainable Livelihood Institute, Auroville addressed the panel and discuss about the Ocean Sustainability.

<https://www.facebook.com/photo.php?fbid=4186584658062363&set=pb.100001326092623.-2207520000.&type=3>

<https://www.youtube.com/watch?v=DNXMUbsV6M&t=638s>

**CELEBRATION OF WORLD OCEAN DAY**  
Date: June 8<sup>th</sup>, 2021 / 8.00 - 9.00 pm IST (7.30 AM California)  
**PANEL DISCUSSION**  
**Coastal communities of Indian Ocean Region: Sustainability, Innovation and Livelihood**  
MODE: SATHYABAMA INSTITUTE ONLINE PLATFORM

  
Dr. Gopal Iyengar, Scientist G,  
Ministry of Earth Sciences, GoI

  
Dr. Vivekanandan, National  
Consultant, ICAR - CMFRI

  
Dr. Adam Schlenger,  
Science Director, Innovation 4.4,  
Ocean Funders, USA

  
Dr. G. Dharani, Scientist -F & Group  
Head - MBT, NIOT (MoES) Chennai

  
Ms. Sara Jolena Wolcott, Director,  
Sequoia Samanvaya, USA

  
Mr. Ramasubramanian,  
Sustainable Livelihood Institute

[E-Certificate will be given to the registered participants]

**Patrons**  
Dr. Manjaveena Johnson, Chancellor  
Dr. Marie Johnson, President  
Ms. Maria Bernadette Tamilarasi Johnson,  
Vice President  
Dr. T. Sasipriya, Vice Chancellor

**Chair Person & Organizing Secretary**  
Dr. B. Sheela Rani,  
Director (Research)

**Convenors**  
Dr. D. Inbakandan,  
Head & Scientist E, COR  
Dr. S. Sakshini,  
Advisor, SU-TBI

**Moderators**  
Mrs. C. Anu, JRF - MoES, COR  
Registration Fee  
Last Date for Registration : 07/06/2021  
For Registration  
<https://forms.gle/187q401601v03q7>

**ORGANIZED BY**  
CENTRE FOR OCEAN RESEARCH  
COL-DR., JEPPIAAR RESEARCH PARK  
**SATHYABAMA**  
INSTITUTE OF SCIENCE AND TECHNOLOGY

IN ASSOCIATION WITH  
EARTH SCIENCE AND TECHNOLOGY CELL  
MINISTRY OF EARTH SCIENCES



Towards the education, innovation and awareness on Ocean Sustainability, Faculty Development Program (FDP) on MARINE BIO & NANOTECHNOLOGY was jointly organized by Centre for Ocean Research, & Department of Biotechnology, Sathyabama Institute of Science and Technology in association with Earth Science and Technology Cell, Ministry of Earth Science.

The topics covered were Marine biofouling and its control using nanomaterials; Statistical analysis: R and Data visualization; Nanomaterials: Synthesis and application from marine sources; Marine bioresources for aquaculture diseases management; *Vibrio harveyi*: Genomic insights into a NGS approach; Characterization and DNA barcoding of Polychaetes; Infrared spectroscopy to characterize marine compounds; GC-MS metabolomics to characterize marine compounds; Marine Natural Products; Application of fish cell lines; Toxic effect of nanomaterials; Seaweeds: A potent bioresources; Nanomaterials for Agricultural application; Carbonate Chemistry in sea water and its impacts; Ocean Acidification and Fish gut microbiome; Value addition and application of live feed-Artemia; Transcriptomics – Seaweed ice ice disease; Innovation, IPR and Bio – Entrepreneurship and Why do we have to work for Ocean Sustainability?. The FDP was beneficial for faculties, teachers and research scholars to seed the awareness sustainable use of ocean resources and its protection.

<https://www.youtube.com/channel/UCNQ3ByrTjF0jLbMSBVRzRjA/search?query=Online%20faculty%20development%20program%20on%20Marine%20Bio%20%26%20Nanotechnology>  
<https://www.facebook.com/photo.php?fbid=4714189315301892&set=pb.100001326092623.-2207520000.&type=3>

## LIFE OF LAND (SDG 15)



In 2015 the United Nations adopted 17 interconnected Sustainable Development Goals (SDGs) addressing the global challenges of poverty, inequality, climate change, environmental degradation, prosperity, peace, and justice. The goals are to be achieved by 2030.

The 15th Sustainable Development Goal is to protect, restore and promote sustainable use of terrestrial ecosystems, sustainably manage forests, combat desertification, and halt and reverse land degradation and halt biodiversity loss. It has 12 specified targets related to how to preserve and sustainably use the Earth's terrestrial species and ecosystems.

### **15.1 Centre for Climate Change Studies (CCCS)**

Indigenous plants as nectar and pollen source are planted within the campus to propagate insect biodiversity. *Olepa schleini*, a polyphagous insect moth with wider host range was first time identified from the campus premises in 2020 on native ivy gourd plants. Gut associated microbiota of *Olepa species* in association with adaptation to diverse food sources is studied at the Centre for Climate Change Studies, Sathyabama Institute of Science and Technology.



Further, in March 2020, mung bean yellow mosaic virus disease infestation in legume plants was identified from Chengalpattu district and was controlled with proper recommendations.

In July 2021, scientists at CCCS have rescued an injured Common Quail bird in the campus. The bird will be released into their natural habitats once they recover from the injuries.

## 15.2 Centre for Remote Sensing and Geoinformatics

Centre for remote sensing and Geoinformatics of Sathyabama Institute of Science and Technology has taken significant steps for achieving these targets. We have undertaken a major research project sponsored by Council for Scientific and Industrial Research (CSIR), India focussing on developing flash flood monitoring (Project reference number, 23(0034)/19/EMR II). Flash flooding is responsible for heavy loss and degradation of land and environment. This research project contributes a lot towards SDG 15.1 (CONSERVATION AND RESTORATION OF TERRESTRIAL AND FRESHWATER ECOSYSTEMS). Lakes are considered as the great sources of fresh water. We have conducted resistivity surveys for storage assessment of lake water. Few field pictures are provided below:



Anthropogenic disasters (floods and droughts) affect the fresh water ecosystems. We have conducted a national conference on “Recent Advances in Anthropogenic Disaster Monitoring (RAADM 2019). This conference was sponsored by Ministry of Earth Sciences and aimed at exchanging ideas on disaster monitoring and fresh water ecosystems (LINK IN FACEBOOK page of Sathyabama: <https://www.facebook.com/SathyabamaOfficial/posts/2707195592634452>). Students learnt a lot about techniques to monitor floods, droughts and cloud bursts. This conference also aids at addressing SDG 15.1.

We are engaged in research focussing on exploring land use and land cover changes using remote sensing and GIS. We have explored changes in Land Use and Land Cover (LULC) over

Baramulla district of Kashmir using remote sensing and Geographic Information System (GIS). This work examined the impact of changes in forest cover on Ecology and economy of the study area. Result reported in this study highlighted the importance of restoration of forest areas (Meer, Mohammad Suhail, and Anoop Kumar Mishra. "Land Use/Land Cover Changes over a District in Northern India using Remote Sensing and GIS and their Impact on Society and Environment." *Journal of the Geological Society of India* 95, no. 2: 179-182.). This significant work contributes to SDG 15.2 (END DEFORESTATION AND RESTORE DEGRADED FORESTS)

For increasing the productivity of the underutilized land, groundwater availability and quality was explored for a case study in Thiruvannamalai. The outcome of the study was validated in Vengikal village and this work was funded by Department of Science and Technology. This important research contributes towards to SDG 15.3 (END DESERTIFICATION AND RESTORE DEGRADED LAND). This research work yielded few quality publications (Santhanam, K., Abraham, M. and Mishra, A.K.. Productivity Improvement of Wasteland in Drought-Prone, Overdrafted and Rocky Terrain Watershed: A Case Study of Upper Thuringalar Watershed in Ponnaiyar Basin Tamil Nadu, India. *National Academy Science Letters*, pp.1-4.). Remote sensing techniques present an advanced tool for improved monitoring of biodiversity and natural habitats.

We have conducted a two days national seminar funded by Indian Space Research Organization on “Emerging trends in Satellite Technology and applications”. Various techniques to monitor biodiversity and natural habits were discussed in the conference and students learnt a lot about these tools. Sustainable Development Goal 15.5 (PROTECTION



OF BIODIVERSITY AND NATURAL HABITATS) was addressed during this conference. A picture showing Dr. P.Nila Rekha, Principal Scientist, Central Institute of Brackish water Aquaculture(CIBA)/ICAR, Chennai delivering a talk during this seminar:

Facebook link of this conference can be accessed at <https://www.facebook.com/SathyabamaOfficial/posts/2326412590712756>.

We have devised a unique technique by integrating methods combining the information obtained by geo-hydrological field mapping and those obtained by analysing multi-source remotely sensed data in a GIS environment for better understanding the Groundwater condition in hard rock terrain. This work contributes very significantly towards conservation of mountain ecosystems. Thus, this work adds to partial accomplishment of 15.4 (ENSURE CONSERVATION OF MOUNTAIN ECOSYSTEMS). Use of Earth Observation Images and GIS Techniques for Groundwater Exploration in Hard Rock Terrain. *Journal of Geography and Cartography*, 2(1.)

We also have devised techniques for exploring near real time flash flooding using satellite observations. Flash flooding is serious contributor to land degradation. Accurate assessment and forecasting of these events are very essential for mitigation of land degradation. Thus, this significant work is very crucial for the accomplishing the goal 15.3 (END DESERTIFICATION AND RESTORE DEGRADED LAND). Results were published in three high impact journals with following details:

A two-weeks certificate course on, “Geospatial Technology in Agricultural Resource Management” was conducted by the institute in association with Indian Society for Remote Sensing, Chennai chapter from Sep 01-Sept 15 2021. In the workshop, the role of GIS in climate smart agriculture for assessment of crop area extent, water resource management, identification of pest and diseases, yield assessment studies, land suitability assessment and precision agriculture were discussed by eminent speakers from around the country.

We only have one planet, and we are proud to be working hard to protect it. We are committed to use it responsibly now, and conserve it for the future and for the betterment of our next generation.



## SDG 16: Peace, Justice and Strong Institutions

## SDG 16: Peace, Justice and Strong Institutions

Sathyabama Institute of Science and Technology Deemed to be University is committed to working towards the United Nation's Sustainable Development Goals (SDGs) through its governance, teaching and learning, community engagement, partnerships and research.

Sathyabama Institute of Science and Technology aims to build a scholarly community committed to the public good and underpinned by an ability to create impact. The university has created a network with 100 universities across the globe by entering into Memorandum of Understanding to share research, information and good practice with the aim of promoting peace, justice and strong institutions in line with Sustainable Development Goal 16.



The university has organized programs on refugees and asylum seekers issues in the Taliban 2.0 International Workshop offering a wide range of understanding about the issue. This initiative has motivated students to understand the importance of refugee outreach programme that includes role of student volunteer work.

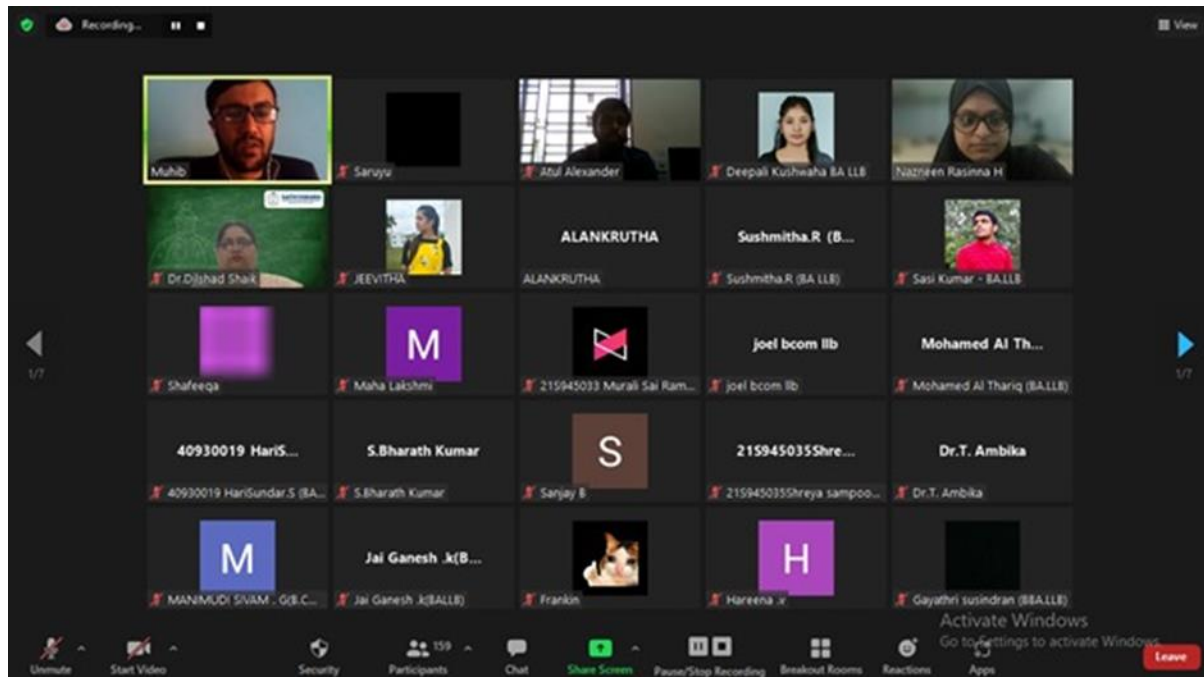

The School of Law also has a support program to fight the scourge of modern slavery in the form of Human Trafficking that blights the lives of millions. Sathyabama School of Law conducts pioneering research regarding Anti human Trafficking by associating with various NGO's and formed a club to curb Modern Slavery. The university has also teamed up with the International Justice Mission to help victims of modern slavery to come forward to stop their exploitation.





The university has various initiatives at the local level to foster youth participation in the electoral process, particularly among youth in marginalized communities. Various Legal Awareness Camps has been organized to listen to vulnerable groups , give them a voice and engage them in the political process.

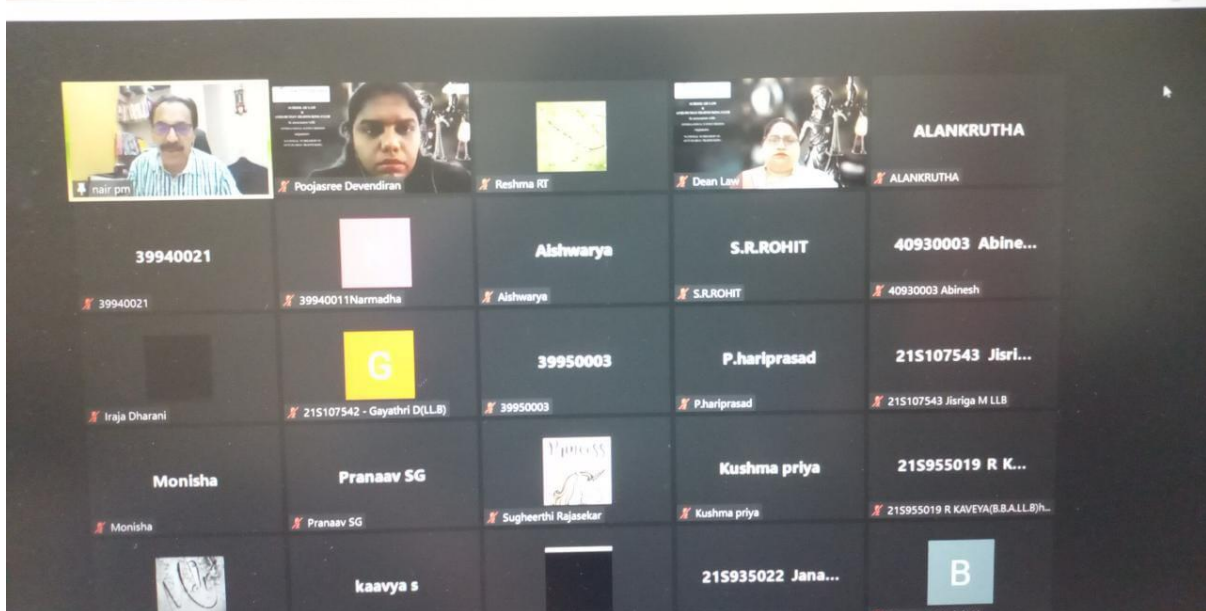



KALYANI PRESENTATION pptx (Protected View) - Microsoft PowerPoint

Protected View This file originated from an Internet location and might be unsafe. Click for more details. Disable Editing

VJKALYAN

### Types of Harassment

- Bullying**  
Any type of psychological, verbal or physical abuse or aggression
- Harassment or mobbing**  
Behaviours such as taunts, threats, spreading false rumors, snubbing or alienating the victim (can also be a violent behaviour)
- Cyber stalking/ cyber bullying**  
Using digital media or social applications to perpetrate personal offenses

Slide 4 of 18 "Of the Threats" English (India)

Sathyabama also offers courses related to global human rights issues and faculty members have participated in many international programs on international law and linguistic minorities, among other areas of research. Moreover, the institution offers programs on to explore the birth of international human rights thinking and the struggle to balance competing rights while examining international human rights legal systems.

The university also hosts programs by State Human Rights Commission and Judicial officers, nationally recognized expertise in probation, policing, applied criminology and community and criminal justice.

### **16.1 Social justice at the heart of promoting health and wellbeing**

Satyabhama Institute Health and Wellbeing Strategy has led to the University partnering with local communities to expand nursing training for our ageing population, train volunteers and specialists in regional and remote communities, and establish a preventative, and allied health and research facility. Access to justice supports health and wellbeing- Through its pro-bono legal services such as Legal Aid programs for local communities, the School of Law is improving legal support for local communities around the University, with supervision from qualified lawyers, our law students provide free legal advice on a range of social welfare issues to the five adopted villages.





awareness organized by School of Law.

Corruption — in all its forms and manifestations of unethical and dishonest behaviour — undermines the rule of law and the protection of human rights. It diverts funds from their intended purposes and erodes trust in democratic institutions. A vast programme of observance of anti-vigilance week by creating

Our constitution provide democratic institutions but are often not sufficiently implemented to make these institutions effective, accountable and inclusive. Sathyabama Institute of Science and Technology organized many programs to create awareness about non-discriminatory laws and policies for sustainable development.

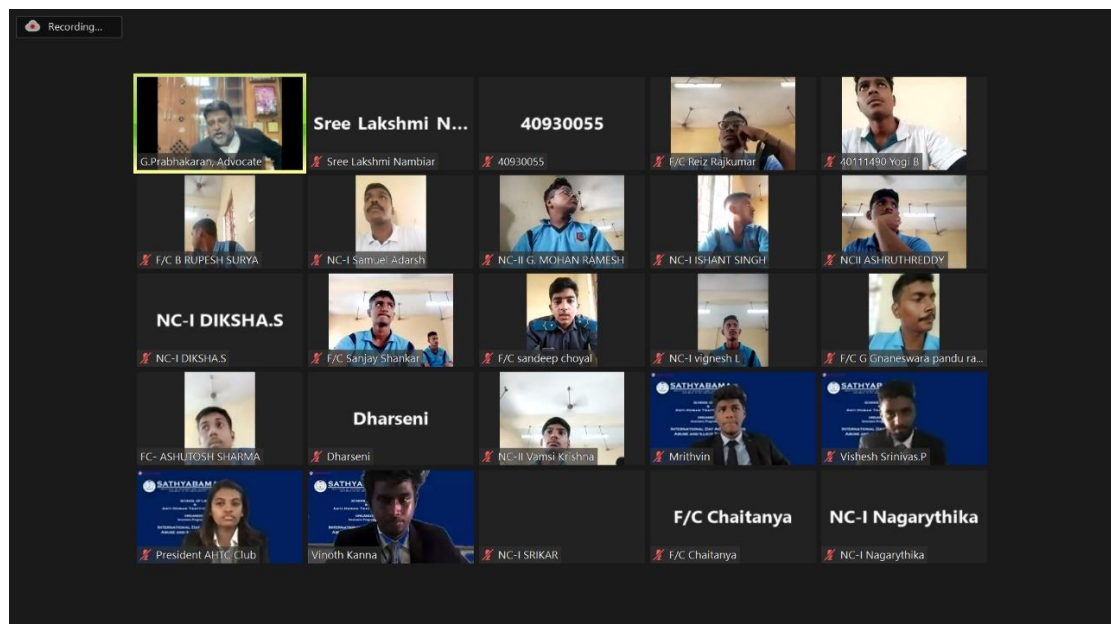

## 17 PARTNERSHIPS FOR THE GOALS



### GOAL 17: PARTNERSHIPS FOR THE GOALS

Stronger partnerships are very essential for sustainable development to mobilize resources, share knowledge and technologies and gain synergistic advantage. Sathyabama Institute of Science and Technology strives to promote partnerships and collaborative agreements with national and international organisations and Universities that facilitate the achievement of sustainable development.

Sathyabama is well connected both at national and international level. It is involved in the collaborative activities such as Joint Academic Programmes and Joint research Programmes with partners across the world. The collaboration has resulted in knowledge sharing with academicians, scientists and researchers across the world. The Collaborations keeps the research and development efforts of our Institution on par with the research and development happening throughout the world. We are able to set targets, goals and benchmarks for us when we work with international counterparts, so that we are sure that we don't lag behind anyone in terms of quality education, research and innovation.

We work in coordination with many Government organisations, Government Agencies, local administrative bodies and Non-Governmental organisations to enhance, support and achieve the sustainable development goals.

#### 17.1 Research Collaborators at National level

The Institution is involved in various sponsored and collaborative R&D projects funded by National Organizations like

- Indian Space Research Organization (ISRO)
- Department of Science and Technology (DST)

- Department of Bio Technology (DBT)
- Indira Gandhi Centre for Atomic Research (IGCAR)
- Defence Research and Development Organization (DRDO)
- Board of Research in Fusion Science and Technology (BRFST)
- Combat Vehicles Research and Development Establishment (CVRDE)
- Central Leather Research Institute (CLRI)
- Bharatiya Nabhikiya Vidyut Nigam Limited (BHAVINI)
- All India Council for Technical Education (AICTE)
- Indian Space Research Organization (ISRO)
- Indian council for Medical Research (ICMR).

Many of our research projects are sponsored by various Ministries like

- Ministry of Human Resource Development (MHRD),
- Ministry of Earth Sciences (MoES) and
- Ministry of Environment and Forests (MoEF).

Our researchers have also collaborated with the Universities across India for doing joint research and made joint publications with the faculty working in other Indian Universities.

### **17.2 Internationalization at Sathyabama**

Over the past 10 years India has become an increasingly attractive study destination for students across the globe. To cater to the growing demands of Internationalization of education, Indian Universities are undergoing transformation transcending National boundaries.

With its admirable academic ambience and excellent research facilities, Sathyabama Institute of Science and Technology has all the features of a world class University that has the potential to become an attractive destination for Higher Education to the students across the Globe.

### **17.3 Centre for Academic Partnership and International Relations**

Sathyabama Institute of Science and Technology has a devoted Centre, Known as Centre for Academic partnership and International Relations that establishes international linkages and alliances to promote collaborative activities. The Centre has been instrumental in the establishment of international tie ups and has initiated collaborations with International

Universities and Research Organisations across the globe. The Centre coordinates all the International Programmes.

#### **17.4 International Alliances and Collaboration**

Sathyabama Institute of Science & Technology has alliances with leading Universities and research establishments across the globe. We have more than 150 partner universities across the world with which we are involved in various collaborative activities that includes student exchange, staff exchange, joint research and joint publications. The Institution actively takes part in several bilateral programmes with the objective of promoting relationships with Countries across the world. We have international students, researchers and academic staff members in our campus through international exchange.

In a truly globalised institution, everyone should have opportunities to acquire international exposure, and career experience. Sathyabama aims at promoting internationalisation and believes that internationalisation strategies are to be driven by educational imperative. The University wishes to provide international exposure and learning experience to students and thereby improving their employability through Student mobility programmes. The University also provides opportunity to the Faculty members to network and learn among international counterparts through staff exchange programmes. Our Institution sends faculty members on exchange programmes to partnering Universities and receives Faculty members from the Partnering Universities across the world.

To promote internationalization we focus on cooperation with universities and other partners worldwide.

We work towards internationalization with the following goals

1. Promoting and supporting international research cooperations and research activities
2. Encouraging and supporting international mobilities for students, faculty and researchers.



OUR STUDENTS AT MAHSA UNIVERSITY, MALAYSIA

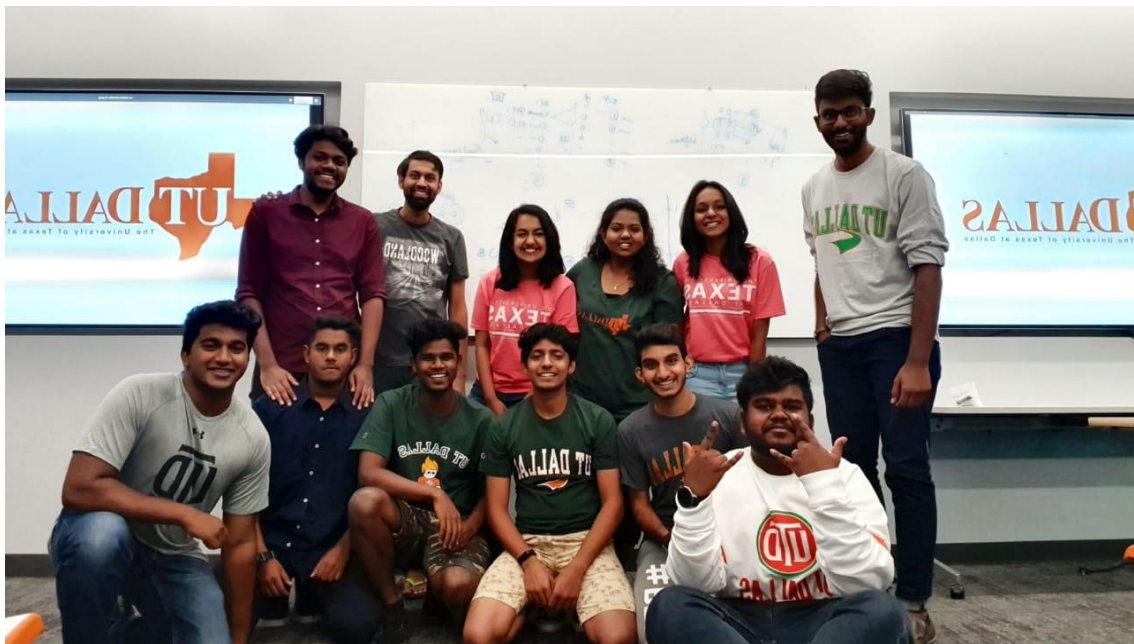

OUR STUDENTS AT UNIVERSITY OF TEXAS AT DALLAS, USA



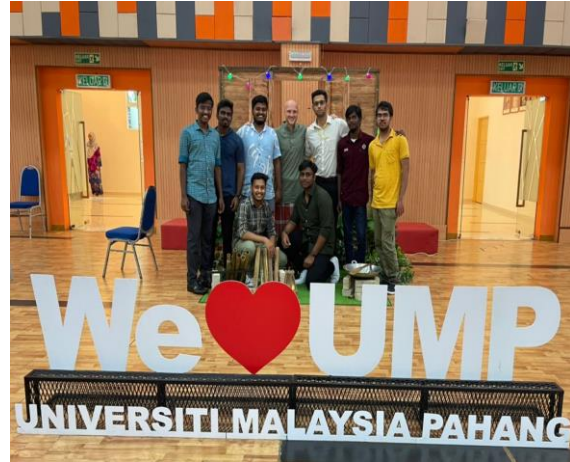

OUR STUDENTS AT UNIVERSITY MALAYSIA PAHANG(UMP), MALAYSIA



OUR STUDENTS AT NATIONAL UNIVERSITY OF SINGAPORE(NUS), SINGAPORE



OUR STUDENTS AT UNIVERSITY OF CRAIOVA, ROMANIA



OUR STUDENTS PARTICIPATING IN GLOBAL ACADEMIC EMERSION  
PROGRAMME IN GERMANY



OUR STUDENTS PARTICIPATING IN INTERNATIONAL SOCIAL BUSINESS PROGRAM BY  
DAFFODIL UNIVERSITY, BANGLADESH



OUR STAFFS AT MAHSA UNIVERSITY, MALAYSIA



OUR STAFFS AT UNIVERSITY TECHNOLOGY MALAYSIA, MALAYSIA



OUR STAFFS AT UNIVERSITY OF TRANSPORT AND COMMUNICATIONS (UTC), VIETNAM

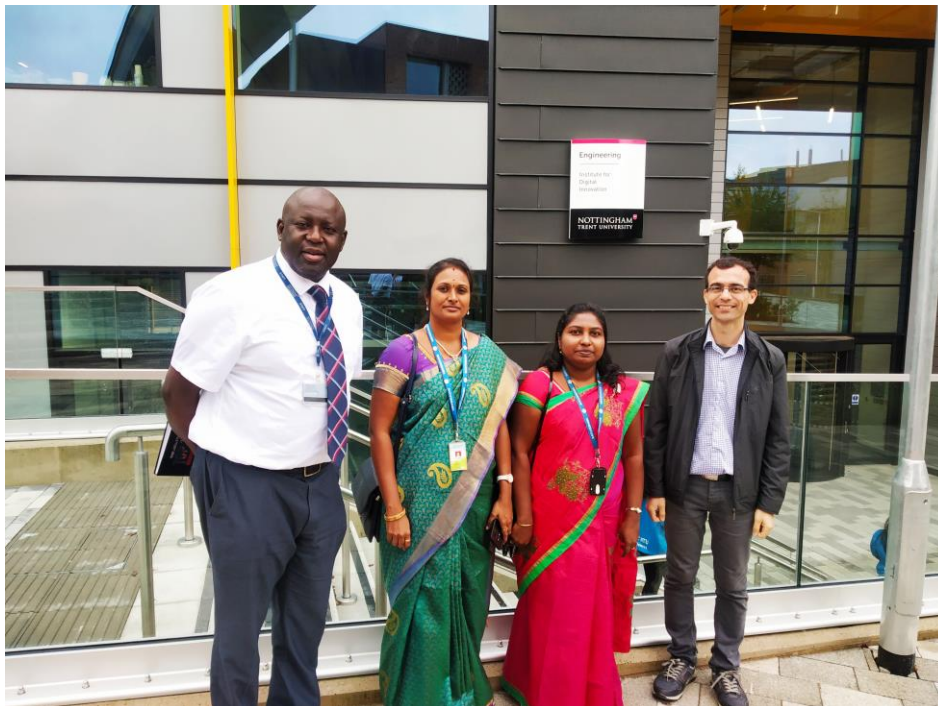

OUR STAFFS AT NOTTINGHAM TRENT UNIVERSITY, UK



OUR STAFFS AT DAFFODIL UNIVERSITY, BANGLADESH



OUR STAFFS AT INTERNATIONAL STAFF WEEK ORGANIZED BY UNIVERSITY TECHNOLOGY MALAYSIA, MALAYSIA

## 17.5 Erasmus Plus-International Credit Mobility Programme

We have association with some of the Universities in European Countries through the Erasmus+ International Credit Mobility Project. We have sent our faculty members on exchange to a Poland University through Erasmus Plus Exchange Programme funded by the European Union. Two of our faculty members have been to Powislanski College in Kwidzyn, Poland IN 2019 and Wszechnica Polska Academy of Applied Sciences in Warsaw, Poland IN 2022.



OUR FACULTY MEMBERS AT POLAND SELECTED UNDER ERASMUS PLUS MOBILITY PROGRAMME

## 17.6 Mevlana Exchange Programme

Our Institution has signed Mevlana Exchange Protocol with some of the Universities in Turkey, to initiate Mevlana Exchange Programme. Mevlana Exchange Programme is a programme funded by Turkish Higher Education Council, which aims the exchange of students and academic staff between the Turkish higher education institutions and higher education institutions of other countries. Our students go on exchange and undergo one semester in Universities at Turkey under the Mevlana Exchange Programme.



OUR FACULTY MEMBERS AT TURKEY SELECTED UNDER MEVLANA EXCHANGE PROGRAMME



OUR STUDENTS AT TURKEY SELECTED UNDER MEVLANA EXCHANGE PROGRAMME

### 17.7 Visiting International Professors

Our Institution invites Professors working in Universities abroad as Visiting International Professors, who come and work for a period ranging from 2-12 weeks. We have Professors from France, Malaysia, Singapore, Bangladesh, and Indonesia working with us.



INTERNATIONAL PROFESSORS AT SATHYABAMA

### Collaborations

Collaboration	Number
International Universities	159
National Universities	10
National - Research & Development Organizations	34
National Industries	87



### **17.8 INDONESIAN DELEGATION VISIT TO OUR INSTITUTION**

An Indonesian Delegation comprising of Rectors, Vice Rectors and Deans representing several Universities in Indonesia visited our Institution and discussed on the possibilities of collaborations.



Visit of Indonesian Delegation

### **17.9 A GLIMSE OF MoU SIGNING WITH INTERNATIONAL UNIVERSITIES**



## 17.10 INTERNATIONAL RESEARCH COLLABORATIONS

Our Scientists and researchers work jointly with international researchers. The following is the list of the International research collaboration for the year 2021.

### 17.10.1 INTERNATIONAL RESEARCH COLLABORATIONS FOR THE YEAR 2020 – 2021

S. No	Scientist/ Faculty Name	Name of the laboratory/ Institute	Year of the Collabo ration	Outcome of the Collaboration
1.	Dr.V.K. Bupesh Raja	Materials Division, Department of Mechanical Engineering, National University of Singapore, Singapore	2020	Publication( <a href="https://doi.org/10.1080/10426914.2020.1832684">https://doi.org/10.1080/10426914.2020.1832684</a> .(W oS. IF: 4.616))
2.	Dr.S. Kumaran	School of Agriculture and Biology, Shanghai Jiao Tong University, Shanghai, 200240, PR China	2021	Publication
3.	Dr.S. Kumaran	Faculty of Science, Chulalongkorn University, Thailand	2021	Issue Editors
4.	Dr.S. Kumaran	Ege University, Turkey	2021	Publication
5.	Dr. Amit Kumar	University of Antwerp, Belgium	2021	Combined publications
6.	Dr.K. Nagamani	The University of Kitakyushu, Japan	2020	International Conference
7.	Marykutty Abraham	University of Houston, Houston, Texas 77204, United States	2021	Joint Publication
8.	Dr. Shyju	University of Concepcion, Chile	2021	One Paper in JVST A – Published
9.	Dr G Murugadoss	Ural Federal University, Yekaterinburg 620002, Russia	2020- 2021	Research Papers
10.	Dr G Murugadoss	Kind Saud University, Riyadh 11451, Saudi Arabia	2020- 2021	Research Papers
11.	Dr G Murugadoss	Dongguk University, Biomedical Campus, Gyeonggi-do 10326, South Korea	2020- 2021	Research Papers
12.	Dr G Murugadoss	University of Concepcion, Concepcion, Chile	2020- 2021	2020-2021

13.	Dr G Murugadoss	Alagappa University, Karaikudi 630003, India	2020-2021	Research Papers
14.	Brijitta J	Jülich Centre for Neutron Science (JCNS) at Heinz Maier-Leibnitz Zentrum (MLZ), Forschungszentrum Jülich GmbH, Germany	2020-2022	Manuscript under preparation
15.	Brijitta J, Sanjeevi Prasath	Division of Physical Chemistry, Lund University, Sweden	2020-2022	<a href="https://pubs.acs.org/doi/10.1021/acs.langmuir.1c00288">https://pubs.acs.org/doi/10.1021/acs.langmuir.1c00288</a>
16.	Brijitta J	Institut Laue–Langevin, Grenoble, France	2019-2022	Manuscript under preparation
17.	Brijitta J	University of Florence, Italy	2021	Work in Progress
18.	Brijitta J	Università degli Studi di Bari Aldo Moro, Italy	2021	Proposal submitted towards Indo-Italy Network Call
19.	Dr. M. Manjula	National University of Science and Technology “MISiS”, Moscow, Russia	2019	Research work published in International journal
20.	Scientist/Rajkumar	IISc Bangalore	2020	Research paper
21.	Dr. J R Deepak	Wollo University, Ethiopia	2021	Online Faculty Exchange Program for four weeks on AutoCAD Design Software Training for Automotive Engineering PG students

#### 17.10.2 NATIONAL RESEARCH COLLABORATIONS FOR THE YEAR 2020 – 2021

S.No	Scientist/ Faculty Name	Name of the laboratory/ Institute	Year of the Collaboration	Outcome of the Collaboration
1.	Sheetal Amraotkar - Faculty Advisor for the Design and competition	Chitrakoota School and Solar Decathlon collaboration for research and design of Net zero energy and Net zero water Project for Construction worker Housing for the School Mr.Kavin Kumar - Industry Partner for the Project	2021	Design once accepted, will be executed on Site, Masters Sustainable Architecture & Building Management students get to execute a live project and learn. Recognition if Solar Decathlon competition is won, results shall be declared in March 2022

2.	Ar. Sukirtha Suresh	Mr.Kavin Kumar, Director - Engineering Project Management Consultancy and Research (EPMCR) Private Limited	2020-2021	As part of MOU entered on 8th Aug 2019, Provided Industrial Training for 2 students Facilitated placement of 1 student post graduation. Carried out Joint research activities in the fields of Work Safety Plan, Quality Management for Precast Concrete Technology & Safety & Risk Assessment by way of Dissertation projects. Actively engaged as Industry Partner for the Solar Decathlon competition
3.	Dr.T.Rajasekar	ICMR_JALMA	2020	Publication
4.	Dr.S. Kumaran	Pandit Deendayal Petroleum University, Gandhinagar 382 007,	2020 - 2021	Publication
5.	Dr. Jerirne Joseph	National Institute for Research in TB	2020	Publication
6.	Dr. S. Thanga Suja	Indian Institute of Rice Research	2020	Project submitted and experiment ongoing
7.	Dr. S. Thanga Suja	Sun Agrobiotech research Centre	2020	Project submitted
8.	Dr. S. Thanga Suja	School of Agriculture, Karunya Institute of Technology and Science	2020	Article submitted
9.	Dr. S. Thanga Suja	National institute of Plant Genome Research	2021	Computational work in progress
10.	Dr. S. Prakash	Zoological Survey of India	2021	Combined publications
11.	Dr. S. Prakash	ICAR-NBFGR	2021	Combined publications
12.	Centre for laboratory Animal Technology and Research	Govt. Siddha Medical College	2020	Animal Projects

13.	Centre for laboratory Animal Technology and Research	SRM Institute of Science and Technology	2020	Animal Projects
14.	J. Baalamurugan	RSD, SQRMG, IGCAR	2020	Publication
15.	Dr. S. Supriya	CLRI	2020 - 2021	M.Sc Project
16.	Dr. K. Gobi Saravanan	CIPET, bhubaneswar	2021	Publications, Journal of Materials Chemistry B
17.	Brijitta J, Sanjeevi Prasath, Saravanan C	Indira Gandhi Centre for Atomic Research, Kalpakkam	2020	<a href="https://www.sciencedirect.com/science/article/abs/pii/S2468023020307926">https://www.sciencedirect.com/science/article/abs/pii/S2468023020307926</a>
18.	Brijitta J	University of Hyderabad	2021	Manuscript Communicated
19.	Brijitta J, Sanjeevi Prasath	Indian Institute of Technology Madras	2019-2021	<a href="https://www.sciencedirect.com/science/article/abs/pii/S0167577X20305590#!">https://www.sciencedirect.com/science/article/abs/pii/S0167577X20305590#!</a> , <a href="https://pubs.acs.org/doi/abs/10.1021/acs.langmuir.1c00288">https://pubs.acs.org/doi/abs/10.1021/acs.langmuir.1c00288</a>
20.	Brijitta J, Sanjeevi Prasath, Saravanan C	Polymer Research Centre, Indian Institute of Science Education and Research Kolkata	2018-2020	<a href="https://www.sciencedirect.com/science/article/abs/pii/S0167577X20305590#!">https://www.sciencedirect.com/science/article/abs/pii/S0167577X20305590#!</a>
21.	D.S.Jayalakshmi	Loyola Institute of S&T	2020-2021	Publication
22.	D.S.Jayalakshmi	SSN college	2020-2021	Publication
23.	Scientist/Govind Kumar/ Dr.B.kanimozhi	Tata Technologies ltd jamshedpur/ Research and development	2020	Research paper

## 17.11 POST-DOCTORAL FELLOWSHIPS/RECOGNITIONS RECEIVED BY FACULTY AND STUDENTS DURING THE YEAR 2021

### 17.11.1 OUTREACH/AWARENESS PROGRAMMES

School of Building and Environment, Department of Architecture has organized a Path Finder programme on 'Decoding Architecture and Design' - Architecture Outreach Programme which was conducted for the school students to give them an idea about Architecture.

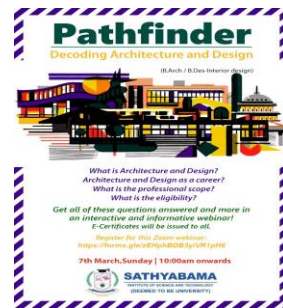

School of Building and Environment, Department of Architecture has organized a Path Finder programme on 'Decoding Architecture and Design' -Architecture Outreach Programme which was conducted for the school students to give them an idea about Architecture.

Centre for Climate Change Studies had organized Earth day 2021 lecture as a part of creating awareness on protecting our environment. p

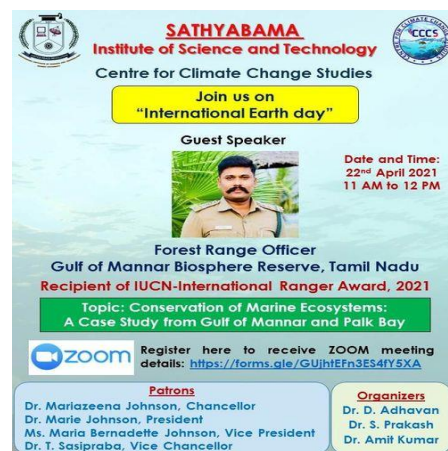



Centre for Climate Change Studies Had organized Seagrass awareness month during March 2021.

Centre for Climate Change Studies has organized a programme on Farmer extension services to create awareness among farmers on March 2020

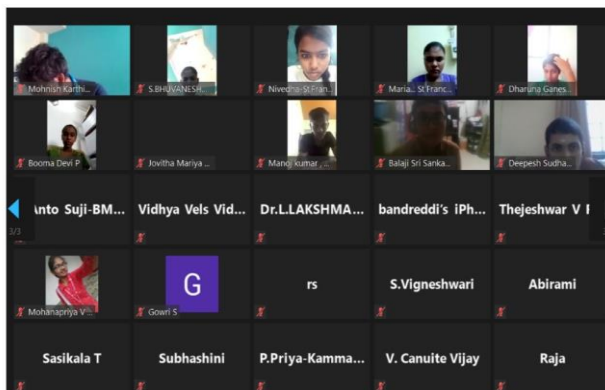

Centre for laboratory Animal Technology and Research had organized a research workshop on Animal Experiment, Lab Animal handling and Research Workshop from June 2020 – April 2021.

Centre for Waste Management jointly with Department of Visual Communications had organized “E-No-Waste” an On-line Contest for School children to create awareness on E waste management.

**SATHYABAMA INSTITUTE OF SCIENCE & TECHNOLOGY**  
(Deemed to be University)

DEPARTMENT OF VISUAL COMMUNICATION  
CENTRE FOR WASTE MANAGEMENT  
&  
VANS CHEMISTRY

**E-NO WASTE**  
An Online Contest

Rules:

- Participants should fill out the registration form to participate in the contest.
- Age Limit - This contest is open for 12 years and above.
- All the end product / solution should reach us not later than 05/03/2021.
- After completing your product take a picture and send it to us.
- The top ten will be invited to participate in the online award placed in the mid of 03/2021.
6. No cash award for financial stability and all procedural measures to be taken with existing rules.
7. Creative content submitted by contestants should be original and not include any infringement of third party intellectual rights.
8. The event organizers will inspect the final output via video call app.
9. The jury decision is final.
10. Participants will get an E-Certificate.
11. The online winners will be recorded in the National Register of Opportunities in Entrepreneurship and Start-ups - E-Entrepreneurship.
12. EASE 2020 to be held on 20th July 2020.

**Cash Prize will be awarded for the Top 3 Contestants**

**DO NOT FORGOT TO REGISTER FOR THE CONTEST**

**FOR MORE DETAILS CONTACT:**  
Mr. A. Sarathkumar  
Sathyabama Institute of Science & Technology  
www.sathyabama.ac.in



**Classroom interactive series for participants of MBCC - 2021**

Organizers- Dr. Amil Kumar, Dr. S. Prakash, Centre for Climate Change Studies, Sathyabama Institute of Science and Technology, Chennai  
Registered participants will receive ZOOM link to attend the event

<p><b>Dr. Nilesh Kumar</b> Associate Professor of Centre for Emerging Climate Research, Our Atmospheric Effect in Contemporary World Date: 04<sup>th</sup> Feb, 10:11 AM</p>	<p><b>Dr. Vardhan Patankar</b> Program Special, Marine Waste Conservation Society, India Date: 04<sup>th</sup> Feb, 10:11 AM</p>	<p><b>Dr. Nilin Trivedi</b> DSG-INSPIRE Faculty, DIRECT Centre for Energy (DIRECT) Centre Institute of Chemical Technology, Mumbai Date and Time: 04<sup>th</sup> February 2021, 10:11 AM</p>
<p><b>Dr. Armit Kumar Mishra</b> Research Fellow, Centre for Climate Change Studies, Sathyabama Institute of Science and Technology, Chennai Date and Time: 07<sup>th</sup> February 2021, 10:00 AM to 10:30 AM</p>	<p><b>Dr. Amil Kumar</b> Project Scientist, National Centre for Coastal Research (NCCR), Chennai Date and Time: 04<sup>th</sup> March 2021, 10:00 AM to 11:00 AM</p>	

Centre for Climate Change Studies had organized classroom interactive series During January – March 2021

Centre for Waste Management, Centre, Centre for Nanoscience and Nanotechnology &, Department to Electronics and Communication Engineering had organized An Awareness Programme on E-Waste Collection and Management during March 2021.







The Department of Computer Science organized an online programme to teach Govt School students Asthinapuram on 'Introduction to IoT'

The Department of Computer Science organized a lecture series for Higher Secondary School students on various aspects of Computing.

The Department of Computer Science organized a Quiz Contest Brainiac for the School students.



### 17.12 FACULTY EXCHANGE / RESEARCH PROGRAMME / JOINT CONFERENCE IN THE YEAR 2020 - 2021

Sl. No.	Name of the collaborating agency with contact details	Name of the participant	Year of collaboration	Duration	Nature of the activity
1	DST-SERB	Dr.Lesith Jeeva Kumari	2019 - 2021	2 Years	NPDF
2	University of Nebraska, Omaha, USA	Dr.Madan Kumar	2019 - 2021	2 years	Senior Post Doctoral Fellow
3	Kaohsiung Medical University,	Mr. S. Manigandan	2019 - 2020	October 1st 2019 – January	Short-Term Research Internship (STRI) Program

	Taiwan			31st 2020	
4	UNIS, Brazil	Dr. Wilson Missina Faria	2020	January 27th – February 3rd 2020	Visiting International Professor
5	UNIS, Brazil	Dr. Adirana Rodrigues Pereira	2020	January 27th – February 3rd 2020	Visiting International Professor
6	Mahsa University, Malaysia	Participants are Staffs from Mahsa University & Sathyabama with Speakers - Dr. A. Annam Renita , Dr. S.S. Dawn	2020	May 12th - May 16th 2020	5-Day online FDP on Education for Sustainable development
7	Syiah Kuala University, Indonesia	Participants are Staffs from Syiah Kuala University & Sathyabama with Speaker - Dr. Dilshad Shaik	2020	May 18th - May 22th 2020	5-Day online FDP on Gender Sensitization and Human rights
8	UNIS, Brazil	Participants are Staffs from UNIS & Sathyabama with Speakers - Dr. T. R. Kalailakshmi, Dr. Nithya Shankar, Mr. John Paul	2020	May 25th - May 30th 2020	One week webinar series for Faculty
9	STIKI Malang, Indonesia	Dr. B.Bharathi	2020	June 15th 2020	International Seminar Series
10	UNIS, Brazil	Dr. S.S. Dawn	2020	June 29th 2020	VI Unis Group International Congress - I International Conference U.Experience
11	STIKI Malang, Indonesia	Participants from STIKI Malang & Sathyabama with Speaker - Dr. Pushpa Nagini	2020	July 6th - July 11th 2020	One Week Faculty Development Programme on Engaging Students Online and Offline

		Sripada			
12	Mahsa University, Malaysia	Participants from Mahsa University & Sathyabama	2020	July 16th - July 17th 2020	International e-Conference on Bioengineering for Health & Environment
13	University Malaysia Pahang & University Putra Malaysia	Participants of University Malaysia Pahang, University Putra Malaysia & Sathyabama	2020	August 7th - August 9th 2020	3rd International Conference on Frontiers in Automobile & Mechanical Engineering (FAME 2020)
14	University of Westminster, UK	Staff from University of Westminster, UK & Sathyabama	2020	August 24th - August 29th 2020	CRISPR/Cas9 Human Genome Engineering :Basics and Applications
15	University of Technology Sydney, Australia	Participants from University of Technology Sydney, Australia & Sathyabama	2020	September 10th 2020	International Symposium on the “Power of Non-Violence- A Gandhian Principle for Global Integrity”
16	TIE-UPS, Provinsi Kepulauan Bangka Belitung, Indonesia, Provinsi Gorontalo, Indonesia, Dinas Pendidikan Pemuda dan Olahraga DIY, Indonesia	Participants from all the organizing university with Speakers - Dr. Pushpa Nagini Sripada, Dr. Kishore Sonti, Ms. Anitha Nathan	2020	October 6th - October 8th 2020	Communication Mentoring & Interactive tools for Virtual Teaching
17	Gyeongsang National University, South Korea	Participants from Gyeongsang National University & Sathyabama	2020	November 23rd - November 25th 2020	e-Conference on Advancements in Materials Science and Technology (iCAM-2020)
18	U.Experience, Brazil	Dr. Devyani Gangopadhyay	2020	November 24th 2020	International webinar: Sustainability and Smart

					Cities
19	Universitas Kanjuruhan Malang, Indonesia	Dr A Chitra Devi	2020	November 28th 2020	2nd Annual Conference on Social Sciences & Humanities 2020
20	U-Experience , Brazil ,Meisei University-Japan, Transilvania University, Romania, British Teaching University of Georgia, Western caspia university, azerbaijan, Free university of Bozen-Bolzano, Italy	Participants from all the organizing university	2020	December 10th - December 12th 2020	I International students Symposium
21	Kyoto University, Japan	Dr. Maharshi Bhaswant C	2020	2019-2020	Long Term ICMR-DHR International Fellowship for Young Indian Biomedical Scientists
22	Wollo University, Kombolcha Institute of Technology, Ethiopia	Dr. V K Bupesh Raja	2021	January 21st 2021	Ethiopia's First International Automobile Industry 4.0 - One Week Online Training Certification Program (AUTO-2021)
23	Wollo University, Ethiopia	Mr. J. R. Deepak	2021	February 27th 2021	International Webinar Series on Latest Trends in Automobile (Horse Power - 2021)
24	Wollo University, Kombolcha Institute of Technology, Ethiopia	Mr. J. R. Deepak	2021	April 4th - April 25th 2021	Online Faculty Exchange
25	Wollo University, Kombolcha	Participants from Wollo University, Kombolcha	2021	April 4th 2021	International Faculty Exchange Program on AutoCAD Design

	Institute of Technology, Ethiopia	Institute of Technology, Ethiopia			
26	Wollo University, Kombolcha Institute of Technology, Ethiopia	Dr. R. B. Durairaj	2021	April 16th 2021	International Workshop on Fundamentals of Robot Programming
27	Group UNIS	Dr. Preethi Sheshadri	2021	May 20th 2021	VII International Congress
28	University of Nebraska, Omaha, USA	Dr. Madan Kumar	2021	June 2019- June 2021	Senior Post Doctoral Fellow
29	Gyeongsang National University, South Korea	Dr. J. THEERTHAGIRI	2021	July 2019- July21	Korean Research Fellowship (KRF)

## 17.13 OUTCOMES OF THE COLLABORATIVE RESEARCH

### PUBLICATIONS (2021)

S.No	Name of the First Author & Designation	Name of the Corresponding Author	Title of the Paper	Published date Vol/Issue	Name of the Journal	I.F
1.	Sanjeevi Prasath. S	Brijitta. J	Adsorption of Anionic Dyes Using a Poly(styrene-block-4-vinylpyridine) Block Copolymer Organogel	25 March 2021, 37, 13, 3996–4006	ACS, Langmuir	3.882
2.	Sanjeevi Prasath. S	Brijitta. J	Temperature Responsive Poly(N-isopropylacrylamide- <i>block</i> -styrene) Block Copolymer Coatings with Tunable Hydrophilicity	7 Nov 2020, Volume :21, 100800	Surfaces and Interfaces	4.837
3.	Dr. M. Rajasekar, Scientist-C	M. Rajasekar	Recent development in fluorescein derivatives	13 August 2020, 1224, 129085	Journal of Molecular Structure	3.196
4.	Dr. M. Rajasekar, Scientist-C	M. Rajasekar	Recent Trends in Rhodamine derivatives as fluorescent probes for biomaterial applications	7 March 2021, 1235, 130232	Journal of Molecular Structure	3.196
5.	S. Muruganandam	G. Murugadoss	Effect of co-doped (Ni <sup>2+</sup> :Co <sup>2+</sup> ) in CdS nanoparticles: Investigation on Structural and Magnetic	05/05/2021	Applied Physics A	2.584

			Properties			
6.	G.Murugadoss	G. Murugadoss	Crystal stabilization of $\alpha$ -FAPbI <sub>3</sub> perovskite by rapid annealing method in industrial scale	08-04-2021	Journal of Materials Research and Technology	5.039
7.	G. Manibalan	G. Murugadoss	Novel chemical route for synthesis of CeO <sub>2</sub> -ZnO nanocomposite towards high electrochemical supercapacitor application	16/03/2021	Journal of Materials Science: Materials in Electronics	2.478
8.	G. Manibalan	G. Murugadoss	Synthesis of heterogeneous NiO nanoparticles for high performance electrochemical supercapacitor application	05/02/2021	Journal of Materials Science: Materials in Electronics	2.478
9.	V. Sudha	G. Murugadoss	Structural and morphological tuning of Cu-based metaloxide	09/02/2021	Scientific Reports	4.379
10.	G. Murugadoss	G. Murugadoss	Silver Decorated CeO <sub>2</sub> Nanoparticles for Rapid Photocatalytic Degradation of Textile Rose Bengal Dye	13/01/2021	Scientific Reports	4.379
11.	N. Venkatesh	G. Murugadoss	Sunlight-driven enhanced photocatalytic activity of bandgap narrowing Sn-doped ZnO nanoparticles	04/01/2021	Environmental Science and Pollution Research	4.223
12.	M. Praveen Kumar	G. Murugadoss	Enhanced electrocatalytic activity of CuO-SnO <sub>2</sub> nanocomposite in alkaline medium	04/01/2021	Applied Physics A	2.584
13.	G. Manibalan	G. Murugadoss	Facile Synthesis of NiO@Ni(OH) <sub>2</sub> - $\alpha$ -MoO <sub>3</sub> Nanocomposite for Enhanced Solid-State Symmetric Supercapacitor Application	20-10-2020	Journal of Colloid and Interface Science	8.128
14.	G. Murugadoss	G. Murugadoss	Synthesis of Cu <sub>2</sub> O-Cu(OH) <sub>2</sub> nanocomposite from CuSCN precursor by a facile chemical precipitation method	20-10-2020	Materials Letters	3.423
15.	N. Venkatesh	G. Murugadoss	Visible light-driven photocatalytic dye degradation under natural sunlight using Sn-doped CdS nanoparticles	30/07/2020	Environmental Science and Pollution Research	4.223
16.	S. Muruganandam	G. Murugadoss	Large-scale preparation of ZnS-ZnO-SnS nanocomposites: Investigation on structural and optical properties	03-07-2020	Optik	2.443
17.	Gobi	Gobi	Silver-calcia stabilized zirconia	10 March	Surfaces	4.837

	Saravanan Kaliaraj	Saravanan Kaliaraj	nanocomposite coated medical grade stainless steel as potential bioimplants	2021	and Interfaces	
18.	S.Kathiravan	Gobi Saravanan Kaliaraj	A Novel Experimental Setup for in situ Oxidation Behavior Study of Nb/Hf/Ti (C-103) Alloy for High Temperature Environments	28-06-2021	Materials Letters	3.423
19.	Archana Rajendran	Suresh Sagadevan	Synthesis, growth, supramolecularity and antibacterial efficacy of 3,4-dimethoxybenzoic acid single crystals	13-12-2020	Chemical Physics Letters	2.328
20.	Suresh Sagadevan	Suresh Sagadevan	Photocatalytic activity and antibacterial efficacy of titanium dioxide nanoparticles mediated by Myristica fragrans seed extract	18-03-2021	Chemical Physics Letters	2.328
21.	Ruchi P.Jain	Rajesh Rajaian Pushpabai	Mass spectrometric identification and denovo sequencing of novel conotoxins from vermivorous cone snail ( <i>Conus inscriptus</i> ), and preliminary screening of its venom for biological activities in vitro and in vivo	Volume 28, Issue 3, 24-12-2020 Pages 1582-1595	Saudi Journal of Biological Sciences	4.219
22.	Rajesh. Rajaian Pushpabai	Franklin, J.B.	Diversity of Conopeptides and Conoenzymes from the Venom Duct of the Marine Cone Snail <i>Conus bayani</i> as Determined from Transcriptomic and Proteomic Analyses	April 03 2021, 19(4), 202	<i>Mar. Drugs</i>	5.118
23.	Yasrib Qurishi	Rajesh. Rajaian Pushpabai	Anticancer activity in HeLa and MCF-7 cells via apoptotic cell death by a sterol molecule Cholesta-4,6-dien-3-ol (EK-7), from the marine ascidian <i>Eudistoma kaverium</i> .	Volume 33, Issue 4, 27-Mar-2021 101418	<i>Journal of King Saud University</i>	4.011
24.	K.Bhuvanewari	T. Pazhanivel	Visible light driven reduced graphene oxide supported ZnMgAl LTH/ZnO/g-C <sub>3</sub> N <sub>4</sub> nanohybrid photocatalyst with notable two-dimension formation for enhanced photocatalytic activity towards organic dye degradation.	Volume 197, 26-03-2021	<i>Environmental Research</i>	6.498
25.	Weng Kiat Tan	Sivakumar Manickam	Fish pond water treatment using ultrasonic cavitation and advanced oxidation processes	Volume 274, 25-01-2021	<i>Chemosphere</i>	7.086
26.	Gobi Saravanan Kaliaraj	Kamalan Kirubakaran	Role of bovine serum albumin in the degradation of zirconia and its allotropes coated 316L SS for	25 September 2020	Materials Chemistry and Physics	4.094

			potential bioimplants	258/123859		
27.	Dr. Ranjita Misra, Scientist-C	Dr. Ranjita Misra	Smart nanotheranostic hydrogels for on-demand cancer management	2020 Nov 17 ;26(2)	Drug Discovery Today	7.851
28.	Dr. Ranjita Misra	Dr. Ranjita Misra	EGFR targeted Mn-doped ZnO fluorescent nanocrystals for cancer theranostic applicatn	18-02-2021	Materials Today Communications	3.383
29.	Dr. Ranjita Misra	Dr. Ranjita Misra	Establishing the promising role of novel combination of triple therapeutics delivery using polymeric nanoparticles for Triple negative breast cancer therapy	31-07-2020	BioImpacts	3.831
30.	Dr. Ranjita Misra	Dr. Ranjita Misra	Nanobiosensor-based diagnostic tools in viral infections: Special emphasis on COVID-19	2021 Jun 23:e2267	Reviews in Medical Virology	6.989
31.	Vinita Vishwakarma	Vinita Vishwakarma	Investigation on surface sulfate attack of nanoparticle-modified fly ash concrete	18 July, 2020 27, 41372–41380, (2020)	Environmental Science and Pollution Research	4.223
32.	C.O.Ogunkunle	C.O.Ogunkunle	Co-application of indigenous arbuscular mycorrhizal fungi and nano-TiO <sub>2</sub> reduced Cd uptake and oxidative stress in pre-flowering cowpea plants	19-09-2020 20:101163, (2020)	Environmental Technology & Innovation	5.263
33.	Roselin Sobha Joseph Boopaphi	Vinita Vishwakarma	Study on Polymeric coatings on fly Ash concrete under seawater	03 November 2020, 28, 9338–9345, (2021)	Environmental Science and Pollution Research	4.223
34.	Clement Oluseye Ogunkunle	Clement Oluseye Ogunkunle	Short-term ageing of facile pod-derived biochar reduced soil Cd mobility and ameliorated Cd toxicity to soil enzymes and leaf bioactive compounds of tomato	08 December 2020, 00:1-11, (2021)	Environmental Toxicology and Chemistry	3.742
35.	Dawn S S	Vinita Vishwakarma	Recovery and recycle of wastewater contaminated with heavy metals using adsorbents incorporated from waste resources and nanomaterials-A Review	18 January 2021, (2021), 273, 129677	Chemosphere	7.086
36.	Karthik Kumar C	Shyju T.S.	Ba-Acceptor Doping in ZnSnN <sub>2</sub> by Reactive RF Magnetron Sputtering: (002) faceted Ba-ZnSnN <sub>2</sub> films	06-10-2020 Vol. 855, (2021), 157380	Journal of Alloys and Compounds	5.316



37.	Karthik Kumar C	Shyju T.S.	Impact of Cu Addition on the Optoelectronic Properties of Zn <sub>3</sub> N <sub>2</sub> Thin Films: n to p-type Transitions	11-01-2021 Vol. 265, (2021), 115039,	Materials Science & Engineering B	4.051
38.	Shyju T. S.	Shyju T. S.	Highly crystalline methylammonium lead iodide films: Phase transition from tetragonal to cubic structure:	08 February 2021 Vol 39 (2021)	Journal of Vacuum Science and Technology A	2.427
39.	T. Karuppiah,	A. Pugazhendhi	Processing of electroplating industry wastewater through dual chambered microbial fuel cells (MFC) for simultaneous treatment of wastewater and green fuel production	30-06-2021	International Journal of Hydrogen Energy	5.816
40.	A. Swetha,	J.Arun	Review on hydrothermal liquefaction aqueous phase as a valuable resource for biofuels, bio-hydrogen and valuable biochemicals recovery	21-06-2021	Chemosphere	7.086
41.	J. Arun	Pugazhendhi A	Upgradation of Nostoc punctiforme under subcritical conditions into liquid hydrocarbons (bio-oil) via hydrodeoxygenation: Optimization and engine tests	17-02-2021	Journal of Environmental Chemical Engineering	5.909
42.	PV Gopirajan	KP Gopinath	Optimization of hydrothermal gasification process through machine learning approach: Experimental conditions, product yield and pollution	29-04-2021	Journal of Cleaner Production	9.297
43.	J Mahima,	Pugazhendhi A	Effect of algae (Scenedesmus obliquus) biomass pre-treatment on bio-oil production in hydrothermal liquefaction (HTL): Biochar and aqueous phase utilization studies	08-03-2021	Science of The Total Environment	7.963
44.	P SundarRajan,	KP Gopinath,	Insights into valuing the aqueous phase derived from hydrothermal liquefaction	30-03-2021	Renewable and Sustainable Energy Reviews	14.982
45.	RS Jayaraman,	A. Pugazhendhi	Co-hydrothermal gasification of microbial sludge and algae Kappaphycus alvarezii for bio-hydrogen production: Study on aqueous phase reforming	15-03-2021	International Journal of Hydrogen Energy	5.816
46.	A Kartik,	A. Pugazhendhi	A critical review on production of biopolymers from algae	17-02-2021	Bioresource Technology	9.642

			biomass and their applications			
47.	S Adithya,	M. Govarathanan	A critical review on the formation, fate and degradation of the persistent organic pollutant hexachlorocyclohexane in water systems and waste streams”.	08-02-2021	Chemosphere,	7.086
48.	R Neha,	J. Arun	Nano-adsorbents an effective candidate for removal of toxic pharmaceutical compounds from aqueous environment: A critical review on emerging trends,	04-02-2021	Chemosphere,	7.086
49.	J Rajagopal,	KP Gopinath,	Photocatalytic reforming of aqueous phase obtained from liquefaction of household mixed waste biomass for renewable bio-hydrogen production”,	10-12-2020	Bioresource Technology	9.642
50.	J Arun,	J Arun,	Bioenergy perspectives of cattails biomass cultivated from municipal wastewater via hydrothermal liquefaction and hydro-deoxygenation”.	24-08-2020	Fuel,	6.609
51.	D Akhil,	KP Gopinath,	Production, characterization, activation and environmental applications of engineered biochar: a review”,	16-01-2021	Environmental Chemistry Letters,	9.027
52.	PV Gopirajan	KP Gopinath,	Optimization of hydrothermal liquefaction process through machine learning approach: process conditions and oil yield”,	03-01-2021.	Biomass Conversion and Biorefinery,	4.987
53.	A Suresh	A. Bhatnagar	Recent Advancements in the Synthesis of Novel Thermostable Biocatalysts and Their Applications in Commercially Important Chemoenzymatic Conversion Processes”	17-12-2020	Bioresource Technology	9.642
54.	P Srivatsav	A. Bhatnagar,	Biochar as an Eco-Friendly and Economical Adsorbent for the Removal of Colorants (Dyes) from Aqueous Environment: A Review”	18-12-2020	Water	3.103
55.	J. Arun,	J. Arun	Sustainable and eco-friendly approach for phosphorus recovery from wastewater by hydrothermally carbonized microalgae: Study on spent bio-char as fertilizer”	11-08-2020	Journal of Water Processing Engineering ,	5.485
56.	S Naveen	KP Gopinath,	A Solar Reactor for Bio-diesel Production from Pongamia Oil: Studies on transesterification Process Parameters and Energy	21-11-2020	Chinese Journal of Chemical Engineering	3.171

			Efficiency”,			
57.	S Naveen,	KP Gopinath,	Novel Solar Parabolic Trough Collector cum Reactor for the Production of Biodiesel from Waste Cooking Oil using Calcium Oxide catalyst derived from seashells waste”.	15-09-2020	Chemical Engineering and Processing-Process Intensification	4.237
58.	R Malolan,	K P Gopinath	Green ionic liquids and deep eutectic solvents for desulphurization, denitrification, biomass, biodiesel, bioethanol and hydrogen fuels: a review”.	22-10-2020	Environmental Chemistry Letters,	9.027
59.	J Arun,	J Arun,	Technical insights into the production of green fuel from CO <sub>2</sub> sequestered algal biomass: A conceptual review on green energy”.	02-10-2020	Science of the Total Environment,	7.963
60.	K. P. Gopinath	K. P. Gopinath	Environmental applications of carbon-based materials: a review”.	04-09-2020	Environmental Chemistry Letters,	9.027
61.	A Krishnan	KP Gopinath,	Ionic liquids, deep eutectic solvents and liquid polymers as green solvents in carbon capture technologies: a review”.	23-07-2020.	Environmental Chemistry Letters,	9.027
62.	J. Arun	Pugazhendhi A	Hydrothermal liquefaction of <i>Prosopis juliflora</i> biomass for the production of ferulic acid and bio-oil	14-09-2020	Bioresource technology	9.642
63.	J Balakrishnan	KSR Koteswara Rao, Professor, Dept. of physics, Indian Institute of Science, Bengaluru.	Temperature-and size-dependent photoluminescence in colloidal CdTe and Cd <sub>x</sub> Zn <sub>1-x</sub> Te quantum dots	25 Jan, 2021 Volume: 54 Issue: 14 Page: 145103	Journal of Physics D: Applied Physics	3.207
64.	Dr. G. Ramanjaneya Reddy	Dr. G. Ramanjaneya Reddy,	The Heterogenized Hexazatricyclic Complexes as Solid Acid Catalyst for the Degradation of Rhodamine-b	27, August, 2020	Chemistry Select	2.109
65.	Dr. G. Ramanjaneya Reddy	Dr. G. Ramanjaneya Reddy,	Removal of organic pollutants in water by the MCM-41 anchored with nickel(II) and copper(II) complexes	15-03-2021 101492	Environmental Technology Innovation	5.263
66.	K. Narthana	Dr. J. Theerthagiri	One-step synthesis of hierarchical structured nickel	09-02-2021, Vol.	International Journal of	5.164

			copper sulfide nanorods with improved electrochemical supercapacitor properties	45, 9983–9998.	Energy Research	
67.	T. Dharini	Dr. P. Kuppusami	Tribological properties of YSZ and YSZ/Ni-YSZ nanocomposite coatings prepared by electron beam physical vapour deposition	07 June 2021 (In press)	Ceramics International	4.527
68.	S. Ajith Kumar	Kuppusami. P and Fu Yen Pei	“Co-Doped Ceria Ce <sub>0.8</sub> M <sub>0.1</sub> Gd <sub>0.1</sub> O <sub>2-δ</sub> (M= Sm <sup>3+</sup> , Sr <sup>2+</sup> , Ca <sup>2+</sup> ) and Co-Doped Ceria-Na <sub>2</sub> CO <sub>3</sub> Nanocomposite Electrolytes for Solid Oxide Fuel Cells	03 Oct 2019. Vol. 2, Issue. 10, 6300–6311	ACS Applied Nanomaterials	
69.	Krishnamanikumar Premachandran	Thanga Suja Srinivasan	In silico approach on sequential and structural variability in oryzacystatin and its interaction with cysteine protease enzymes of insect	13-03-2021	Phytochemistry.	4.072
70.	AM Iniyan	Dr. R. Rajesh Kannan	Streptomyces marianii sp. nov., a novel marine actinomycete from southern coast of India	13 Aug 2020	The Journal of Antibiotics	2.649
71.	Swathi Kesh	Dr. R. Rajesh Kannan	Naringenin alleviates 6-hydroxydopamine induced Parkinsonism in SHSY5Y cells and zebrafish model	216-09-2020	Comparative Biochemistry and Physiology Part C: Toxicology & Pharmacology	3.228
72.	Swathi Kesh	Dr. R. Rajesh Kannan	Hesperidin downregulates kinases lrrk2 and gsk3β in a 6-OHDA induced Parkinson’s disease model	16-10-2020	Neuroscience Letters	3.046
73.	TR Jabila Mary	Dr. R. Rajesh Kannan	Cell wall distraction and biofilm inhibition of marine Streptomyces derived angucycline in methicillin resistant Staphylococcus aureus	28-12-2020	Microbial Pathogenesis	3.738
74.	TR Jabila Mary	Dr. R. Rajesh Kannan	β-lactamase inhibitory potential of kalafungin from marine Streptomyces in Staphylococcus aureus infected zebrafish	03-12-2020	Microbiological Research	5.415
75.	Shenbagamoorthy Sundarraaj	Dr. R. Rajesh Kannan	Bisphenol-a alters hematopoiesis through EGFR/ERK signaling to induce myeloblastic condition in zebrafish model	06-05-2021	Science of the Total Environment	7.963
76.	Jhansi Nathan	Dr. R. Rajesh Kannan	In vivo molecular validation of VEGF inhibitor extracted from	June 2020 Vol 49-06	NISCAIR-CSIR	0.496

			marine Actinomycetes in zebrafish embryos	Page 970-974		
77.	S. Prakash	S. Prakash,	Population structure and reproductive performance of the sea anemone associated shrimp <i>Ancylocaris brevicarpalis</i> (Caridea: Palaemonidae).	08 February 2021. 101(1): 109-116	Journal of Marine Biological Association of the United Kingdom	1.394
78.	S. Prakash	S. Prakash,	Influence of lipid-enriched diets on the reproductive performance of ornamental 'hinge-beak' shrimp <i>Rhynchocinetes durbanensis</i> (Caridea: Rhynchocinetidae)	09-11-2020	Aquaculture Research	2.082
79.	Jojoy John	Amit Kumar	Bio-decolorization of synthetic dyes by a halophilic bacterium <i>Salinivibrio</i> sp	21 December 2020. 11:594011	Frontiers in Microbiology	5.640
80.	Dharunya G	Manikantan Syamala Kiran	Modular mucopolysaccharide gelatin naturapolyceutics hydrocolloid biomatrix with cobalt nano-additives for high density vascular network assembly	Volume 181, 30 18-04-2021 Pages 847-857	International Journal of Biological Macromolecules	6.953
81.	P.Priyadasi	Dawn S S	Compositional and Structural Evaluation of <i>Kappaphycus alvarezii</i> Rejects and Solid Food Waste Blends for Bio ethanol Production	24 Aug 2020	Energy Sources, Part A: Recovery, Utilization, and Environmental Effects	3.447
82.	M.Arul Jayan	Dawn S S	Facile preparation of highly dispersed copper promoted cobalt catalyst supported on alumina nanospheres	19 Dec 2020	<u>Materials Letters</u>	3.423
83.	Kumaran Subramanian	Kumaran	Chitin derivatives of NAG and chitosan nanoparticles from marine disposal yards and their use for economically feasible fish feed development	Vol: 281 : 130746 14May 2021	Chemosphere	7.086
84.	Kumaran Subramanian	Saravanan	Bio remediation of Synthetic Textile Dyes Using Live Yeast <i>Pichia pastoris</i>	<u>Volume 22</u> , 101442 20 Feb 2021	Environmental Technology & Innovation	5.263
85.	Kumaran Subramanian	Kumran	Nanoremediation of dimethomorph in water samples using magnesium aluminate	<u>Volume 20</u> , , 101176 25	<u>Environmental Technology</u>	5.263

			nanoparticles	Sept 2020.	<u>&amp; Innovation</u>	
86.	Kumaran Subramanian	Kumaran	Bioconversion of chitin and concomitant production of chitinase and N-acetylglucosamine by novel <i>Achromobacter xylosoxidans</i> isolated from shrimp waste disposal area	Volume: 10:11898 Date: 17 July 2020	Nature Scientific Reports	4.379
87.	Mr. Karthikeyan Subbiahannadar Chelladurai	Dr. S. Jackson Durairaj and Dr. S. Johnson Retnaraj Samuel	Exploring the effect of UV-C radiation on earthworm and understanding its genomic integrity in the context of H2AX expression.	03-12-2020 10, 21005	Scientific Reports	4.379
88.	Seshadri Parthasarathy	V. Ganesh Kumar	A remote conductometric titration method for simultaneous determination of uranium and nitric acid concentrations at elevated temperatures	25-01-2021, Vol.327, pp.1087–1093	Journal of Radioanalytical and Nuclear Chemistry	1.371
89.	Dr. V. Karthick	V. Karthick	Incorporation of 5-Nitroisatin for Tailored Hydroxyapatite Nanorods and its Effect on Cervical Cancer Cells: A Nanoarchitectonics proach	01 <sup>st</sup> Feb 2021 31 (2021) 1946-1953	Journal of Inorganic and Organometallic Polymers and Materials	3.543
90.	Marykutty Abraham	Marykutty Abraham	Effectiveness of Check Dam and Percolation Pond with Percolation Wells for Artificial Groundwater Recharge using Groundwater Model	Nov. 2019 19 (7)	Water Science and Technology-Water Supply	1.033
91.	D.Sivaraman	D.Sivaraman	Neurocognitive Investigation of <i>Morinda tinctoria</i> against Amyloid Beta Induced Oxidative Insult and Cognitive Impairment in Albino Mice: A Phytotherapeutic Approach	28th August 2020	Pharmacognosy Magazine	1.085
92.	D.Sivaraman	D.Sivaraman	A Risk - Benefit Analysis on clinical significance of convalescent plasma therapy in the management of COVID-19	17th August 2020	The Postgraduate Medical Journal BMJ	2.401
93.	P.Govindaraj	Mukesh Doble IIT Madras	Bilayered nanostructure coating on AZ31 magnesium alloy implants for the healing of critical-sized rabbit femoral segmental bone defects	17-06-2020	Nanomedicine: Nanotechnology, Biology, and Medicine	6.458

94.	Pratibha Pramod Chavan	Dr.B.Sheela Rani	A novel image compression model by adaptive vector quantization: modified rider optimization algorithm	9 <sup>th</sup> September , 2020 45:232	Sadhana, Indian Academy of Sciences	1.188
95.	S. Amrin Nisa	K. Govindaraju	Jellyfish venom proteins and their pharmacological potentials: A review	11-02-2021	International Journal of Biological Macromolecules	6.953
96.	Shiv Vendra Singh	Sumit Chaturvedi, G.B Pant University of Agriculture & Technology, Pantnagar	Pyrolysis temperature influences the characteristics of rice straw and husk biochar and sorption/desorption behaviour of their biochar composite	13-June-2020	Bioresource Technology	9.642
97.	M. Kannan	M. Kannan, TNAU, Coimbatore	Ultra-structural and physico-chemical characterization of eggs and egg hairs (setae) of the new invasive pest, fall armyworm, <i>Spodoptera frugiperda</i> (J. E. Smith) in India: A first report.	14-01-2021/ 84 (7) 1422-1430	Microscopy Research and Technique	2.769
98.	K. Raja,	K.Raja, TNAU, Coimbatore	Electrospun polyvinyl alcohol (PVA) nanofibers as carriers for hormones (IAA and GA3) delivery in seed invigoration for enhancing germination and seedling vigor of agricultural crops (groundnut and black gram)	24 October 2020	Polymer Bulletin	2.870
99.	Sumit Chaturvedi	Sumit Chaturvedi, G.B Pant University of Agriculture & Technology, Pantnagar	Characterization, bioenergy value, and thermal stability of biochars derived from diverse agriculture and forestry lignocellulosic wastes	02 January 2021	Biomass Conversion and Biorefinery	4.987
100.	Jyotsna,	Parameswaran .V	Antiviral activity of sulfated polysaccharides from <i>Sargassum ilicifolium</i> against fish Betanodavirus infection	11 March 2021/ 29, 1049-1067	Aquaculture International	2.235
101.	J.Baalamurugan	V.Ganesh Kumar	Recycling of steel slag aggregates for the development of high density concrete: Alternative & environment-friendly radiation shielding composite	10-04-2021	Composites Part B: Engineering	9.078
102.	J.Baalamurugan	V.Ganesh Kumar	Recycling of induction furnace steel slag in concrete for marine	24 May 2021	International Journal of	2.860

			environmental applications towards ocean acidification studies		Environmental Science and Technology	
103.	B Subasini	Dr. Inbakandan D	A comparative study on chitosan nanoparticle synthesis methodologies for application in aquaculture through toxicity studies	18 Mar 2021 15 (4)	IET Nanobiotechnology	1.847
104.	S.U.Mohammed Riyaz	Dr. Inbakandan D	Microbiome in the ice-ice disease of the farmed red algae <i>Kappaphycus alvarezii</i> and degradation of extracted food carrageenan	26May 2021	Food Bioscience	4.240
105.	Ms. K. M. Smita	Dr. L. Stanley Abraham	Biosynthesis of reduced graphene oxide using <i>Turbinaria ornata</i> and its cytotoxic effect on MCF-7 cells	18 May 2021 15 455-464	IET Nanobiotechnology	1.847
106.	R. Vasantharaja	K. Govindaraju	Seaweed polysaccharides as potential therapeutic agents against white spot syndrome virus (WSSV): a mini review	13 August 2020/ 28:2333-2343	Aquaculture International	2.235
107.	D. Vinu	K. Govindaraju	Biogenic zinc oxide, copper oxide and selenium nanoparticles: preparation, characterization and their antibacterial activity against <i>Vibrio parahaemolyticus</i>	12 November 2020, 11, 271–286 (2021)	Journal of Nanostructure in Chemistry	6.391
108.	K. Vijai Anand	K. Govindaraju	Preparation and characterization of calcium oxide nanoparticles from marine molluscan shell waste as nutrient source for plant growth	07 January 2021	Journal of Nanostructure in Chemistry	6.391
109.	R. Namitha	K. Govindaraju	Actinobacteria and their bioactive molecules for anti-WSSV activity: A mini review	17-10-2020	Aquaculture Research	2.082
110.	B Subasini	Dr. Inbakandan D	Curcumin loaded chitosan nanoparticles fortify shrimp feed pellets with enhanced antioxidant activity	14 Nov 2020 120 111737	Materials Science & engineering C, Materials for Biological Application	7.328
111.	Purna Dilip Itrotwar	K. Govindaraju	Influence of nanoscale micro-nutrient $\alpha$ -Fe <sub>2</sub> O <sub>3</sub> on seed germination, seedling growth, translocation, physiological effects and yield of rice ( <i>Oryza sativa</i> ) and maize ( <i>Zea mays</i> ).	13 May 2021, 162:564-580	Plant Physiology and Biochemistry	4.270



112.	Riya Ann Mathew Research Scholar, University of Houston	Riya Ann Mathew	Bioremediation of Diesel Oil in Marine Environment	11-9-2020 75, (2020)	Oil & Gas Science and Technology –Revue d’IFP Energies nouvelles	1.708
113.	Raji P. K	Marykutty Abraham	Modeling and simulation of runoff from an irrigation tank watershed to evaluate the utilizable water	6-1-2021 14 (16)	Arabian Journal of Geosciences	1.827
114.	Dr.A. Anderson, Associate Professor	T. R. Praveenkumar	Exergy and Energy Analysis of $\alpha$ -Fe <sub>2</sub> O <sub>3</sub> -Doped Al <sub>2</sub> O <sub>3</sub> Nanocatalyst-Based Biodiesel Blends—Performance and Emission Characteristics	April 9, 2021. Vol. 143	Journal of Energy Resources Technology	2.903
115.	Dr.A. Anderson, Associate Professor	T R PraveenKumar	Impact of COVID-19 pandemic on plastic surge and environmental effects	29 March 2021	Energy Sources, Part A: Recovery, Utilization, And Environmental Effects	3.447
116.	G. Antony Casmir Jayaseelan	Dr.A. Anderson	Effect of engine parameters, combustion and emission characteristics of diesel engine with dual fuel operation	10 June 2021	Fuel	6.609
117.	Dr.A. Anderson	Praveenkumar T.R.	Lowest emission sustainable aviation biofuels as the potential replacement for the Jet-A fuels	23 October 2020	Aircraft Engineering and Aerospace Techn	0.975
118.	A.Senthilkumar	Dr.A. Anderson	Performance analysis of R600a vapour compression refrigeration system using CuO/Al <sub>2</sub> O <sub>3</sub> hybrid nanolubricants	25 June 2021 Vol.:(0123 456789)13	Applied Nanoscience	3.674
119.	Dr.P.Booma Devi	T. R. Praveenkumar	Influence of high oxygenated biofuels on micro-gas turbine engine for reduced emission	11 Nov 2020 Vol.93 Issue 3	Aircraft Engineering and Aerospace Technology	0.975
120.	Dr.P.Booma Devi	Siriporn Tola	Impact of microalgae biofuel on microgas turbine aviation engine: A combustion and emission study	10 June 2021	Fuel	6.609
121.	Dr. Manigandan	Kathirvel Brindhadevi	Performance, noise and emission characteristics of DI engine using canola and Moringa oleifera	09-12-2020	Fuel	6.609

			biodiesel blends using soluble multiwalled carbon nanotubes			
122.	Dr. Manigandan Sekar	Arivalagan Pugazhendhi	Characterization of polyurethane coating on high performance concrete reinforced with chemically treated Ananas erectifolius fiber	16-09-2020	Progress in Organic Coatings	5.161
123.	Dr. Manigandan Sekar	Arivalagan Pugazhendhi	A review on the pyrolysis of algal biomass for biochar and bio-oil–Bottlenecks and scope	30-09-2020	Fuel	6.609
124.	Dr. Manigandan Sekar	P Thaloor Ramesh, E Palanivelu	Combined Analysis of Heavy Crude Oil Viscosity and Stress Acting on the Buried Oil Pipelines	02-2021	Journal of Pipeline Systems Engineering and Practice	1.952
125.	Dr. Manigandan Sekar	Ming-Tsang Wuade Vinay B.Raghavendra Arivalagan Pugazhendhi Kathirvel Brindhadevi	A systematic review on recent trends in transmission, diagnosis, prevention and imaging features of COVID-19	20-08-2020	Process Biochemistry	3.753
126.	Dr. Manigandan Sekar	P.Gunasekar T.R.Praveen Kumar Tahan Awad Alahmadi N.Subramanian Arivalagan Pugazhendhi	Influence of dynamic position, fluid intake, hydration, and energy expenditure on sustainable mobility transport	14-12-2020	<u>Applied Acoustics</u>	2.639
127.	Dr. Rajasree Shanmuganathan	Manigandan Sekar	Experimental investigation and numerical analysis of energy efficiency building using phase changing material coupled with reflective coating	19-Aug 2020	International Journal of Energy Research	5.164
128.	Dr. Kathirvel Brindhadevi	Manigandan Sekar	Biohydrogen production using horizontal and vertical continuous stirred tank reactor-a numerical optimization	12-Aug 2020 (46,20)	International Journal of Hydrogen Energy	5.816
129.	Dr. Manigandan Sekar	Manigandan Sekar	A review on role of nitrous oxide nanoparticles, potential vaccine targets, drug, health care and artificial intelligence to combat COVID-19	16-June 21	Applied Nanoscience	3.674
130.	Dr. Devaraj Rangabashiam Other Univ	Manigandan Sekar	Effect of Al <sub>2</sub> O <sub>3</sub> and MgO nanofluids in heat pipe solar collector for improved efficiency	25-May 21	Applied Nanoscience	3.674

131.	Ramy Ganesan	Abroad Univ	A detailed scrutinize on panorama of catalysts in biodiesel synthesis	06-02-2021	Science of The Total Environment	7.963
132.	Dr. Manigandan Sekar		Early detection of SARS-CoV-2 without human intervention to combat COVID-19 using drone technology	16-02-2021	Aircraft Engineering and Aerospace Technology	0.975
133.	Sabarathina mShanmugam	Abroad Univ	Pretreatment of second and third generation feedstock for enhanced biohythane production: Challenges, recent trends and perspectives	03-Feb 21 (40, 20)	International Journal of Hydrogen Energy	5.816
134.	Kathirvel Brindhadevi	N. Chi	Effect of reaction temperature on the conversion of algal biomass to bio-oil and biochar through pyrolysis and hydrothermal liquefaction	06-11-2020	Fuel	6.609
135.	ThangavelM athimani	Arivalagan Pugazhendhi	Relative abundance of lipid types among Chlorella sp. and Scenedesmus sp. and ameliorating homogeneous acid catalytic conditions using central composite design for maximizing fatty acid methyl ester yield	19-01-2021	Science of The Total Environment	7.963
136.	Ramachandran Sivaramakrishnan	Arivalagan Pugazhendhi	Insights on biological hydrogen production routes and potential microorganisms for high hydrogen yield	30-01-2021	Fuel	6.609
137.	KandaWhan gchai	Arivalagan Pugazhendhi	Synergistic supplementation of organic carbon substrates for upgrading neutral lipids and fatty acids contents in microalga	13-04-2021	Journal of Environmental Chemical Engineering	5.909
138.	Geetanjali Yadav	L. Chi	Lipid content, biomass density, fatty acid as selection markers for evaluating the suitability of four fast growing cyanobacterial strains for biodiesel production	04-01-2021	Bioresource Technology	9.642
139.	M.S.Meddah	M.S.Meddah	Mechanical and microstructural characterization of rice husk ash and Al <sub>2</sub> O <sub>3</sub> nanoparticles modified cement concret	06-May-2020 (255,20)	Construction and Building Materials	6.141
140.	Gunasekar	-	Hydrogen as the futuristic fuel for the aviation and aerospace industry – review	23-06-2021	Aircraft Engineering and Aerospace tech	0.975
141.	R.Kaja	R.Kaja Bantha	Six sigma in health-care service:	19 May	Internationa	3.329

	Bantha Navas, AP	Navas	a case study on COVID 19 patients' satisfaction	2021	<u>Journal of Lean Six Sigma</u>	
142.	Ghadge, R.R., Dr.S. Prakash	Prakash,S	Experimental investigations on fatigue life enhancement of composite (e-glass/epoxy) single lap joint with graphene oxide modified adhesive	17 Feb 2021 Vol 8, Issue 2	Materials Research Express	1.620
143.	Ghadge, R.R	Prakash,S	Weight minimization of fiber laminated composite beam for aircraft wing construction using exhaustive enumeration algorithm and numerical modeling	18 March 2021	Aircraft Engineering and Aerospace Technology	0.975
144.	Bhingare, N.H., Research Scholar	Bhingare, N.H.,	Enhancement in fire retardant Properties of Coconut Coir/Polyurethane acoustic composites.	26 Aug 2020	Journal of Natural Fibres, Taylor and Francis	5.323
145.	Bhingare, N.H.	Bhingare, N.H.,	Effect of Polyurethane Resin Addition on Acoustic Performance of Natural Coconut Coir Fiber	03 Nov 2020	Journal of Natural Fibres, Taylor and Francis	5.323
146.	Mr. Manoj Kumar Chaudhary	Mr. Manoj Kumar Chaudhary	Experimental investigations and aerodynamic shape optimization of small horizontal axis wind turbine blades	7 April 2021	Transactions of the Canadian Society for Mechanical Engineering	1.450
147.	M. Sangeetha	K.Brindhadevi	Experimental investigation of nano fluid based photovoltaic thermal (PV/T) system for superior electrical efficiency and hydrogen production	Volume 286, Part 2, 21-Oct-2020 119422	Fuel	6.609
148.	M. Sangeetha	S.Nithya	Surface roughness analysis for newly prepared CNT-coated metal matrix: RSM approach	24 May 2021	Applied Nanoscience	3.674
149.	Dr.B. Kanimozhi	R. Kesavakumar	Kaolinite fines colloidal-suspension transport in high temperature porous subsurface aqueous environment: Implications to the geothermal sandstone and hot sedimentary aquifer reservoirs permeability	05/10/2020.Vol.89/101975	Geothermic	4.284
150.	Ms.Aruna	Dr.B.Kanimozhi	Statistical optimization of Closed Loop Pulsating Heat Pipe parameters with R-410a and nanorefrigerant in air conditioning applications	24/05/2021 Vol.1145-51	Energy Source part A: Recovery, Utilization,	3.447

					and Environmental Effects.	
151.	J. Lilly Mercy	J. Lilly Mercy	Genetic Optimization of Machining Parameters Affecting Thrust Force during Drilling of Pineapple Fiber Composite Plates – an Experimental Approach	19 th July 2020	Journal of Natural Fibres, Taylor and Francis	5.323
152.	Mathew Alphonse	Dr. V. K. Bupesh Raja	Optimization of Coated Friction Drilling Tool for a FML Composite	Pages 351-361, online 19 Oct 2020	Materials and Manufacturing Processes	4.616
153.	J Hemanandh	Yuvarajan Devarajan	Experimental investigation on slaughter, fish waste and poultry excrete oil as fuel blends in diesel engine	20 Jan 21	Biomass Conversion and Biorefinery	4.987
154.	Suresh Ramachandran	Rameshbabu Arumugam	Ignition analysis of diesel engine propelled with neat biodiesel containing nanoparticles	06 May 2021.	Energy Sources, Part A: Recovery, Utilization, and Environmental Effects	3.447
155.	Mr.Purusothaman Mani	Mr.Purusothaman Mani	Experimental investigation of drying characteristics of lima beans with passive and active mode greenhouse solar dryers	28.02.2021, Vol.44(5)	Journal Food Process Engineering	2.356
156.	Mr.Purusothaman Mani	Mr.Purusothaman Mani	Thin layer modelling and thermal performance of active mode modified greenhouse solar dryers	10.02.2021	Heat and Mass Transfer	2.464
157.	Mr.R.Siva	R.Siva	Effects of magnesium carbonate concentration and lignin presence on properties of natural cellulosic <i>Cissus quadrangularis</i> fiber composites	30-08-2020 3611-3620	International Journal of Biological Macromolecules	6.953
158.	Nivin Joy	Nivin Joy	Characterization of Titanium Grade 5 Alloy Compressor Blade in A Jet Engine Using Advanced Materials for Optimum Thrust Production	November 12, 2020	International Journal of Turbo & Jet-Engines	1.082
159.	Nivin Joy	Nivin Joy	Temperature Evaluation and Performance Comparison of Various Cooling Techniques in Drilling of Grade 5 Titanium Alloy	June 05, 2021	Thermal Science	1.625
160.	Jayaprabakar J	Jayaprabakar J,	Impact of Methyl, Ethyl, and Butyl Ester Blends of Freshwater	July 8, 2020 , 34,	Energy & Fuels	3.605

			Algae Oil on the Combustion, Performance, and Emissions of a CI Engine	8, 9763–9770		
161.	V.Sriram	Dr.B.Kanimozhi	Comparative analysis of hexagonal boron nitride coated on copper winding in the saline-based heat pipe	August 2020/VOL UME 195(2020) 267-274	Desalination and Water Treatment	1.254
162.	Pradeep Uttam Gaikwad Senthil kumar Gnanamani	Nithya Subramani	Experimental and numerical simulation of the piston engine fueled with alternative fuel blends: CFD approach	08-Feb-2021	Aircraft Engineering and Aerospace Technology	0.975
163.	A.Rameshbabu(Research Scholar), G.Senthil Kumar(Research Supervisor)	A.Rameshbabu	Emission and performance investigation on the effect of nano-additive on neat biodiesel	17-July-2019/43/11	Energy Sources, Part A: Recovery, Utilization, and Environmental Effects	3.447
164.	T. Arunkumar	R.Karthikeyan	Effect of Multiwalled Carbon Nanotubes on Improvement of Fracture Toughness of Spark-Plasma-Sintered Yttria-Stabilized Zirconia Nanocomposites,	22-02-2021 30:3925–3933.	Journal of Materials Engineering and Performance on Surface Engineering	1.819
165.	M. D. F. Al-Aseebee Al-Qasim Green University , Babylon, Iraq	JeyaJeevahan Jayaraj	Influence of rice starch nanocrystals on the film properties of the bionanocomposite edible films produced from native rice starch,	Vol. 16, No. 2, April - June 2021, p. 697 – 704.	Digest Journal of Nanomaterials and Biostructures,	0.963
166.	R B Durairaj	R B Durairaj	Investigations on Mechanical Properties of Titanium Reinforced Glass Ionomer Cement (GiC) – Ceramic Composites Suitable for Dental Implant Applications	Vol. 16, No. 1, January - March 2021, p. 161 - 167	Digest Journal of nanomaterials and Biostructures	0.963
167.	S. Ganesan	S. Ganesan	An experimental study on the influence of an oxygenated additive in diesel engine fuelled with neat papaya seed biodiesel/diesel blends	14-Feb-2020	Fuel	6.609
168.	S. Ganesan	S. Ganesan	Experimental study on utilizing peel oil, diesel and ignition-	4 september	Energy Sources,	3.447

			enhancer blends as fuel for diesel engine	2020,	Part A: Recovery, Utilization, and Environmental Effects	
169.	S. Ganesan	S. Ganesan	Experimental investigation on solar-powered ejector refrigeration system integrated with different concentrators	2 Jan 2021	Environmental Science and Pollution Research	4.223
170.	S. Ganesan	S. Ganesan	Mechanical and Morphological Characteristics Study of Chemically Treated Banana Fiber Reinforced Phenolic Resin Composite with Vajram Resin	16 Jan2021	Journal of Natural Fibers	5.323
171.	S. Ganesan	S. Ganesan	Modelling of biodiesel blend using optimised deep belief network: blending waste cooking oil methyl ester with tyre pyrolysis oil	21-07-2020 ,14(16)	IET Renewable Power Generation	3.930
172.	S. Ganesan	S. Ganesan	Study of Annona squamosa as alternative green power fuel in diesel engine	24 Feb 2021	Biomass Conversion and Biorefinery	4.987
173.	S. Ganesan	S. Ganesan	Detailed study on the effect of different ignition enhancers in the binary blends of diesel/biodiesel as a possible substitute for unaltered compression ignition engine	30-05-2020	Petroleum Science	4.090
174.	S. Ganesan	S. Ganesan	Effect of CeO <sub>2</sub> nano powder as additive in WME-TPO blend to control toxic emissions from a light-duty diesel engine – An experimental study	20-06-2020	Fuel	6.609
175.	S. Ganesan	S. Ganesan	Enhancement Of Internal Combustion Engine Efficiency By Magnetizing Fuel In Flow Line For Better Charge Combustion	September 2020,21(5 )	Heat Transfer Research	2.443
176.	S. Ganesan	S. Ganesan	Production Process Optimization study on the synthesis of Manilkara zapota seed bio-oil and its characterization	06-04-2021	Biomass Conversion and Biorefinery	4.987
177.	S.Dhamodaran	S.Dhamodaran	Comparative Analysis Of Spatial Interpolation With Climatic Changes Using Inverse Distance Method	09 July 2020,12, pages 6725–6734	Journal of Ambient Intelligence and Humanized	7.104

					Computin	
178.	J. Refonaa	J. Refonaa	Remote Sensing Based Rainfall Prediction Using Big Data Assisted Integrated Routing Framework	03 January 2021 (Springer Online)	Journal of Ambient Intelligence and Humanized Computin	7.104
179.	S. P. Godlin Jasil	S.P.Godlin Jasil	Deep learning architecture using transfer learning for classification of skin lesions	17 March 2021	Journal of Ambient Intelligence and Humanized Computng	7.104
180.	Yingying fan (other institute)	Yingying fan	Aerobics players energy level monitoring using iot	26 2021 march	Journal of ambient intelligence and humanized computing	7.104
181.	Jianjuan Liu	Jianjuan Liu	Multi-sensor information fusion for iot in automated guided vehicle in smart city	06/march/2021	Soft computing	3.643
182.	M.Maheswari	Yohan park	Pevrm: probabilistic evolution based version recommendation model for mobile applications	25/1/2021 volume 9/issn: 2169-3536	IEEE ACCESS	3.367
183.	D.Supriya	D.Supriya, Assistant professor, Murugappa polytechnic	IOV-a novel mechanism for initiating secure vehicle data transmission using PSO with two phase authentication	15 March 2021	Journal of Ambient Intelligence and Humanized Computing	7.104
184.	N.Gokilavani	N.Gokilavani, Project Lead, CTS	Test case prioritization to examine software for fault detection using PCA extraction and K-means clustering with ranking	25, pages5163-5172, 5-Jan-2021	Soft computing	3.643
185.	Gokilavani. N	N.Gokilavani	Multi-Objective based test case selection and prioritization for distributed cloud environment	11-01-2021, 82, 103964	Microprocessors and Microsystems	1.525
186.	N.Anusha	N.Anusha, Assistant professor, Andhra pradesh	Automatic Flood Detection in Multi-Temporal Sentinel-1 Synthetic Aperture Radar Imagery Using ANN Algorithms	21-04-2020 Vol 15 No 3 (2020)	International Journal of Computers Communications & Control	2.293
187.	Sreekala T	Sreekala T	HFFPNN classifier: a hybrid approach for intrusion detection based OPSO and hybridization of	16 October 2020	Multimedia Tools and Applications	2.757



			feed forward neural network (FFNN) and probabilistic neural network			
188.	P. Maniraj	Maniraj	Classification of dermoscopic images using soft computing techniques.	11 Apr 2021	Neural Computing and Application	5.606
189.	Dr.K.Ashok kumar	Ashok Kumar	Hybrid Semantic Deep Learning Architecture and optimal Advanced Encryption Standard key management scheme for Secure cloud storage and intrusion detection	2021-05-27	Neural Computing and Applications	5.606
190.	S. Nandhini	S. Nandhini,	Improved crossover based monarch butterfly optimization for tomato leaf disease classification using convolutional neural network	18 February 2021,	Multimedia Tools and Applications	2.757
191.	Varun, research scholar	Dr.K.Ashok Kumar	Integration of recurrent convolutional neural network and optimal encryption scheme for intrusion detection with secure data storage in the cloud	16 May 2021;37:344–370	Computational Intelligence	2.330
192.	Serin V. Simpson	Serin V. Simpson, research scholar	An edge based trustworthy environment establishment for internet of things: an approach for smart cities	4 June,2021, 1-17	Wireless Networks	2.602
193.	Minu Rajasekaran Indra	Nagarajan.G	Fuzzy rule based Ontology Reasoning	July 2020	Journal of Ambient Intelligence and Humanized Computing	7.104
194.	DhanalakshmiA	Dhanalakshmi A	Combined spatial temporal based In-loop filter for scalable extension of HEVC	23 April 2020	ICT Express	4.317
195.	DhanalakshmiA	Dhanalakshmi A	Convolutional Neural Network-based deblocking filter for SHVC in H.265	2 June 2020	Signal, Image and Video Processing	2.157
196.	Antony Jaya Mabel Rani	Antony Jaya Mabel Rani	Rainfall flow optimization based K-Means clustering for medical data	15 April 2021	Concurrency Computation	1.536
197.	Prem Jacob T	Manikandan Ramachandran	Differential spectrum access for next generation data traffic in massive-IoT	Volume 82, 10 Jan 2021, 103951	Microprocessors and Microsystems	1.525

198.	V. Kanimozhi	V.Kanimozhi, & T. Prem Jacob	Artificial Intelligence outflanks all other machine learning classifiers in Network Intrusion Detection System on the realistic cyber dataset CSE-CIC-IDS2018 using cloud computing	17-Dec-20	ICT Express	4.317
199.	Shalaka Prasad Deore	Shalaka Prasad Deore	Devanagari Handwritten Character Recognition using fine-tuned Deep Convolutional Neural Network on trivial dataset	23 September 2020	Sadhana - Academy Proceedings in Engineering Sciences	1.188
200.	T Daniya	T Daniya	Deep Neural Network for disease detection in rice plant using Texture and deep features	19 April 2021	Computer Journal	1.494
201.	M.D.Anto Praveena,	M.D.Anto Praveena, Assistant professor, CSE	An approach to remove duplication records in healthcare dataset based on Mimic Deep Neural Network (MDNN) and Chaotic Whale Optimization (CWO)	05-04-2021, 29(1), pp. 58-67	Concurrent Engineering Research and Applications	1.038
202.	A. Yovan Felix	A. Yovan Felix	Spatial and temporal analysis of flood hazard assessment of Cuddalore District, Tamil Nadu, India. Using geospatial techniques	20-08-2020	Journal of Ambient Intelligence and Humanized Computing	7.104
203.	Y.Bevis Jinila	Y.Bevis Jinila	PPSA: Privacy Preserved and Secured Architecture for Internet of Vehicles	19 February 2021 / 118	Wireless Personal Communications	1.671
204.	Dr.P.Jeyanthi	Bhamare, B.R	A supervised scheme for aspect extraction in sentiment analysis using the hybrid feature set of word dependency relations and lemmas	5th Feb 21	PeerJ Computer Science	1.392
205.	Dr.P.Jeyanthi	K.Perinbam	Fer115, a dysferlin homologue present in vesicles and involved in c2c12 myoblast fusion and membrane repair	9 th November 2020, 9(11), 386; pp1.15	MDPI- BIOLOGY	5.079
206.	Dr.P.Ajitha	E. M. Malathy	Miniaturized Dual-Band Metamaterial-Loaded Antenna for Heterogeneous Vehicular Communication Networks	04 Mar 2021.	IETE Journal of Research	2.333
207.	Dr.S.Revathy Associate professor	Radhika V.	A Novel Approach to Maximize G-mean in Nonstationary Data with Recurrent Imbalance Shifts”	01 January 21 vol. 18, no. 1, pp. 103-113	The International Arab Journal of	0.669

					Information Technolo	
208.	P.Chandrasekar	P.Chandrasekar	Rotating flow through parallel plates with the various inclined magnetic field under the influence of hall current	22 March 2021 ISSN: 1748-8842(Print) ) 1758-4213	Aircraft Engineering and Aerospace Technology	0.975
209.	V.W.J.Anand	V.W.J.Anand	Comparative study by DTM for unsteady viscous flow between the jet engines combustion unit subjected to inclined magnetic field	2 February 2021/Vol: 93, No.3/ PP.514-528	Aircraft Engineering and Aerospace Technology	0.975
210.	Dr. K. Chennakesavulu,	Dr. K. Chennakesavulu,	The effect of latitude and PM2.5 on spreading of SARS-CoV-2 in tropical and temperate zone countries	04-07-2020	Environmental Pollution	8.071
211.	K. Chennakesavulu	K. Chennakesavulu	Study on interaction of p-sulfonato calix[6]arene with arsanilic acid	27-11-2020	Journal of Dispersion Science and Technology	2.262
212.	Janet Sabina Xavier	Karthikeyan Jayabalan,	Syntheses, quantum mechanical modeling, biomolecular interaction and <i>in vitro</i> anticancer – Tubulin activity of thiosemicarbazones	10209 July 2020	Bioorganic chemistry	5.275
213.	Janet Sabina Xavier	Karthikeyan Jayabalan	Virtual and experimental high throughput screening of substituted hydrazones on $\beta$ -Tubulin polymerization	114 13 June 2021	Bioorganic chemistry	5.275
214.	Birendra Nath Mahato	Dr. T. Krithiga	Rapid adsorption of As(V) from aqueous solution by ZnO embedded in mesoporous aluminosilicate nanocomposite adsorbent: Parameter optimization, kinetic, and isotherms studies	01-09-2020 Vol 23	Surfaces and Interfaces- Elsevier	4.837
215.	Dr. T. Krithiga	Dr. J. Aravind Kumar	One-pot Synthesis of $\beta$ -acetamido- $\beta$ -(phenyl) Propiophenone using ZnO/Carbon Nanocomposites	11 Feb 2021 Vol 24, Issue 2	Combinatorial Chemistry & High Throughput Screening	1.339
216.	AG Ramu	Prof. Choi Dongjin, Hongik University.	Surface-tuned hierarchical $\gamma$ -Fe <sub>2</sub> O <sub>3</sub> -N-rGO nanohydrogel for efficient catalytic removal and electrochemical sensing of toxic nitro compounds	03-11-2020 2021/4/1 Vol : 268	Chemosphere, Elsevier	7.086
217.	AG Ramu	Prof. Choi	A facile synthesis of metal	11-11-	Environmental	8.071

		Dongjin, Hongik University.	ferrites and their catalytic removal of toxic nitro-organic pollutants	2020 Vol : 270	tal Pollution, Elsevier	
218.	Durairaj Gopalakrishnan	Mani Ganeshpandian, SRM University	N,N-Ru(II)-p-cymene-poly(N-vinylpyrrolidone) surface functionalized gold nanoparticles: from organoruthenium complex to nanomaterial for antiproliferative activity	25 <sup>th</sup> May 2021 Vol : 50	Dalton Transactions, Royal Society of Chemistry	4.390
219.	M. Manjula, Assistant Professor	Pandiyarasan Veluswamy	Influence of Ternary and Quaternary Inclusion on Bandgap Tuning of CaTe: Prediction of Potential Thermoelectric Mate	18 January 2021, 50, 1759 - 1771	Journal of Electronic Materials	1.938
220.	J.Anita Lett	J. Anita Lett, Suresh Sagadevan	Facile fabrication of Au-loaded CdO nanoconstructs with tuned properties for photocatalytic and biomedical applications	9 <sup>th</sup> January 2021	Journal of Nanostructure in Chemistry	6.391
221.	J.Anita Lett	Suresh Sagadevan, Won Chun Oh	Exploring the thumbprints of Ag-hydroxyapatite composite as a surface coating bone material for the implants	Volume 9, Issue 6, 21-09-2020 Pages 12824-12833	Journal of Materials Research and Technology	5.039
222.	J.Anita Lett, Assistant professor	Suresh Sagadevan	Recent advances in natural polymer-based hydroxyapatite scaffolds: Properties and applications	Volume 148, 5 20-02-2021	European Polymer Journal	4.598
223.	J.Anita Lett	J. Anita Lett	Synthesis and characterization of polypyrrole-coated iron oxide nanoparticles	Volume 8, 9 <sup>th</sup> -02-2021, 025007	Materials Research Express	1.620
224.	M. Divya	A. Joseph Arul Pragasam	Analysis on Dielectric, Thermal, and Mechanical Characteristics of Nickel Boro Phthalate NLO Crystal for Optoelectronic Applications	19/06/2021	Crystal Research and Technology	1.639
225.	D.S.Jayalakshmi	D.S.Jayalakshmi	Theoretical Prediction of Possible Coexistence Of Superconductivity And Antiferromagnetism In Novel Srferubi2, Srru2bi2 And Parent Srfe2bi2 Compounds	Vol. 81, Iss. 2, 2019	University Politehnica of Bucharest Scientific Bulletin Series A	0.903
226.	D.S.Jayalakshmi	D.S.Jayalakshmi	Computational study on unconventional superconductivity and mechanical properties of novel antiferromagnetic (Ca,Sr,Ba)Fe2Bi2 compounds	Vol. 33, No. 28 (2019) 1950341	International Journal of Modern Physics B	1.219

227.	A victor Babu	A victor Babu	A novel study on augmented physical parameters of nickel doped stannic oxide film,	<u>Volume 7, Number 12</u> 9 December 2020	Mater. Res. Express	1.620
228.	S. Ravichandran	S. Ravichandran	Influence of graphene concentration towards the thermo-acoustic and vibrational properties of grapheme-polyvinyl alcohol nano composites	26-03-2021 32, PP 10359–10367 2021.	Journal of Materials Science: Materials in Electronics	2.478
229.	Marwa Mostafa Moharam	Ahmed Esmail Shalan	Semiconductors as Effective Electrodes for Dye Sensitized Solar Cell Applications	09 April 2021	Topics in Current Chemistry	9.060
230.	P. Thamizharasu	S. Shanmugan	Revealing an OSELM based on traversal tree for higher energy adaptive control using an efficient solar box cooker	15 March 2021	Solar Energy	5.742
231.	D.Prabu	P.Senthil Kumar	Potential of nanoscale size zero valent iron nanoparticles impregnated activated carbon prepared from palm kernel shell for cadmium removal to avoid water pollution	5th october 2020/05	International Journal of Environmental and Analytical Chemistry	2.826
232.	D.Prabu	P.Senthil Kumar	Adsorptive elimination of methylene blue dye from aquatic system using biochar produced from cocoa shell	november 2020/203	Desalination and Water treatment	1.254
233.	A Annam Renita	P Senthil Kumar	Effective removal of malachite green dye from aqueous solution in hybrid system utilizing agricultural waste as particle electrodes	<u>Volume 273, 15</u> <u>Jan 2021,</u> <u>129634</u>	Chemosphere	7.086
234.	A Annam Renita	Sunitha Salla	Synthesis of Acid Free Benzaldehyde by Highly Selective Oxidation of Benzyl Alcohol Over Recyclable Supported Palladium Catalyst   Bentham Science (eurekaselect.com)	29 December 2020	Combinatorial Chemistry & High Throughput Screening	1.339
235.	Magesh N.	Annam Renita A.	Adsorption of ciprofloxacin from aqueous solution using surface improved tamarind shell as an economical and effective adsorbent	14-06-2021/	International Journal of Phytoremediation	3.212
236.	J.Aravind Kumar, Assistant Professor	Dr. Saikat Dutta	Kinetics and regression analysis of phenanthrene adsorption on the nanocomposite of CaO and activated carbon: Characterization, regeneration,	334 (2021) 116080 15 April 2021	Journal of molecular liquids	6.165

			and mechanistic approach			
237.	J.Aravind Kumar, Assistant Professor	Dr.T.Krithiga	Acenaphthene adsorption onto ultrasonic assisted fatty acid mediated porous activated carbon-characterization, isotherm and kinetic studies	(2021) 131249 24 June 2021	Chemosphere	7.086
238.	S.Sathish, Associate Professor	<u>Vaithyasubramanian, S.,</u>	Mechanistic model for the batch extraction of oil from avocado seeds available for biofuel production	29 May 2021	International Journal of Green Energy,	2.459
239.	D. Venkatesan Assistant Professor	D. Venkatesan	Thermophysical Properties of Binary Mixtures of Diisopropyl Ether with Methyl Benzoate, Ethyl Benzoate, and Benzyl Acetate at Various Temperatures	06 August 2020	Russian Journal of Physical Chemistry A	0.691
240.	K. Saravanakumar	K. Saravanakumar	Single and competitive sorption potential of date seed-derived biochar during removal of lead (II) and cadmium (II) ions	25-May-21	Environmental Progress & Sustainable Energy	2.431
241.	S Majeed,	S Majeed	Bacteria Mediated Synthesis of Iron Oxide Nanoparticles and Their Antibacterial, Antioxidant, Cytocompatibility Properties	04 September 2020	Journal of Cluster Science, 1-12	3.061
242.	S. Karthick Raja Namasisvayam	S. Karthick Raja Namasisvayam	<i>Terminalia chebula</i> and <i>Ficus racemosa</i> principles mediated repression of novel drug target Las R – the transcriptional regulator and its controlled virulence factors produced by multiple drug resistant <i>Pseudomonas aeruginosa</i> - Biocompatible formulation against drug resistant bacteria	14-08-2020	Microbial Pathogenesis	3.738
243.	Renugadevi K	Valli Nachiyar C	Bioactivity of Dodecanoic Acid Extracted from <i>Geitlerinema</i> sp. TRV57	Feb 2021	Indian Journal of Pharmaceutical Education and Research	0.686
244.	Jayakrishna Tippabathani	Dr. Jayshree Nellore	Temporal changes in key developmental transcription factors in dopamine neurons during MPP <sup>+</sup> induced injury and recovery in zebrafish brain	Vol. 58, February 2021, pp. 45-55	Indian Journal of Biochemistry & Biophysics	1.918
245.	M.Vaishnavi (student)	Dr.M.Radhakrishnan	Antibacterial and anti-HIV activity of extracellular pigment from <i>Streptomyces</i> .sp.S45 isolated from sabarimala forest	Dec 2020 /58	Indian Journal of Experimental Biology	0.818

			soil, india			
246.	Neeharika. D	Dr. Swetha Sunkar	Computational approach for the identification of putative allergens from Cucurbitaceae family members	26-05-2020	Journal of Food Science and Technology	3.713
247.	Dr. Swetha Sunkar	Dr. Swetha Sunkar	<i>CYP2R1 and CYP27A1 genes: An in silico approach to identify the deleterious mutations, impact on structure and their differential expression in disease conditions</i>	25-04-2020	Genomics	5.736
248.	Archana Vasuki	Jemmy christy	<i>Study of mangal based naphthoquinone derivatives anticancer potential towards chemoresistance related Never in mitosis gene A-related kinase 2- Insilico approach</i>	28 <sup>th</sup> June 2021	Molecular Simulation	2.178
249.	Vaishnavi. M	Dr. M. Radhakrishnan	Antibacterial and anti-HIV activity of extracellular pigment from Streptomyces sp. S45 isolated from Sabarimala forest soil, India	Dec 2020; 58; 861-868.	Indian Journal of Experimental Biology	0.783
250.	Y.Swarnalatha	Y.Swarnalatha	Protective role of heptamethoxyflavone on LPS-induced hepatotoxicity	02 Dec 2020	Toxin Reviews	4.266
251.	C. Manoj Kumar	C. Manoj Kumar	Incorporation of nanocatalyst and its behaviour in green concrete structures: mechanical and microstructural study	28/01/2021	Applied Nanoscience	3.674
252.	S. Packialakshmi	S. Packialakshmi	Assessment of groundwater potential using geospatial techniques for urbanized Mambakkam mini-watershed, Kancheepuram district, India	Vol 49(12), Dec 2020	Indian Journal of Geomarine Sciences	0.496
253.	S. Ebin Horrison	Dr. Lilly Rose	Urban heat island intensity and evaluation of outdoor thermal comfort in Chennai, India.	26 March 2021 / Online	Environment, Development and Sustainability	3.219
254.	R. Pandian	R.Pandian	Characterization of Alzheimer MRI Image based on Image Compression Techniques	November 2020, 79/11	Journal of Scientific and Industrial Research	1.056
255.	R. Pandian	R.Pandian	ROI based Hybrid Compression for DICOM Images	August 2020.79/08	Journal of Scientific and Industrial Research	1.056
256.	T. Thaj Mary Delsy	T.Thaj Mary Delsy	Feasibility of Recurrent Neural Network for the Binary	10-01-2021	Microprocessor and	1.525

			Classification of Non Stationary Signals	volume 82, April 2021	Microsystems	
257.	G. Rajalakshmi	G.Rajalakshmi	Performance evaluation of preprocessing techniques for near-infrared spectroscopy signals	05-11-2020-online-	Microprocessors and Microsystems	1.525
258.	V. Amala Rani	V. Amala Rani	Efficient Medical Image Fusion Using 2-DimensionalWT to improve Quality Metrics	08-Jun-21	IEEE Instrumentation & Measurement Magazine,	1.505
259.	Dr.RADHIKA S.	Dr.Radhika S	Steady State Mean Square Analysis of Standard Maximum Versoria Criterion Based Adaptive Algorithm	vol. 68, no. 4, pp. 1547-51, 20 Oct 20	<i>IEEE Transactions on Circuits and Systems II</i>	3.292
260.	Dr.Bharathi. M.L	Dr.Bharathi.M .L/Assistant Professor	Fuzzy Logic controlled Maximum Power Point Tracking for SEPIC converter fed DC drive - A hybrid Power Generation System	12 Nov 2020, 103371	Microprocessors and Microsystems/ELSEVIER	1.525
261.	D.N .S Ravi Kumar	D.N .S Ravi Kumar	Epidemic and transmission priority based data dissemination model in vehicular adhoc networks (VANETs)	24 <sup>th</sup> Oct 2020	Peer-to-Peer Networking and Application	3.307
262.	P.Sivagami	P.Sivagami	IOT based statistical performance improvement technique on the power output of photovoltaic system	18 April 2020	Journal of Ambient Intelligence Humanized Computin	7.104
263.	P.Sivagami	P.Sivagami	Smart methodology for performance improvement of energy sources for home application	17 Feb 2020	Microprocessors & Micro systems	1.525
264.	M. Kavitha	M. Kavitha	New improved two-phase interleaved converter with clamp circuit and diode capacitor cell	28-02-2020	Microprocessors & Micro systems	1.525
265.	Geetha. V	Geetha. V	Performance evaluation of half bridge AC-AC resonant converter by using various load in domestic purpose of induction heating app	26 July 2020, 12, pages 7085-7093 (2021)	Journal of Ambient Intelligence & Humanized Computin	7.104
266.	C.Bhuvaneshwari	C.Bhuvaneshwari	Error Measurement of LCC Resonant Converter for X-Ray	30/6/2020; Vol 56, No.4 , pp 375-385	Russian Journal of Non-destructive Testing	0.692



267.	DR.S.Nirmalraj	DR.S.Nirmalraj	Fusion of visible and infrared image via compressive sensing using convolutional sparse representation	27.11.20	ICT EXPRESS	4.317
268.	DR.S.Nirmalraj	DR.S.Nirmalraj	Biomedical image compression using fuzzy transform and deterministic binary compressive sensing matrix	19 May 2020	Journal of Ambient Intelligence Humanized Computing	7.104
269.	DR.S.Nirmalraj	DR.S.Nirmalraj	An adaptive fusion of infrared and visible image based on learning of sparse fuzzy cognitive maps on compressive sensing	2019 Oct 28:1-1	Journal of Ambient Intelligence Humanized Computing	7.104
270.	V.Senthil Nayagam	V.Senthil Nayagam	Optimization of power losses in electric vehicle battery by wireless charging method with consideration of the laser optic effect	07 Jan 2020 <u>Volume: 53 issue: 3-4</u>	Measurement & Control	1.704
271.	M.Pushpavalli	M.Pushpavalli	KY converter with fuzzy logic controller for hybrid renewable photovoltaic/wind power system	26 June 2020	Transactions on Emerging Telecommunications Technology	2.638
272.	P Madasamy	Lucian Mihet-Popa, ostfold university college, Norway	Neutral point clamped transformer less multilevel converter for Grid connected PV system	19th April 2021 Vol.10 (8),No.977	MDPI Electronics	2.397
273.	P Madasamy	Bharatiraja C, EEE, SRM, Chennai	Hybrid Multicarrier random space vector PWM for the Mitigation the acoustic noise in VSI fed induction motor drive	19th June 2021 10(12),1483	MDPI Electronics	2.397
274.	V.Meenakshi	V.Meenakshi	Design of LCL filter in front end converters suitable for grid connected wind electric generators	Vol.78(12) December 2019	Journal of Scientific & Industrial research	1.056
275.	Ancy Mergi.A	Godwin Premi.M.S.	Implementation analysis of pixel-level image processing based on multiscale transforms	03 August 2020	Computational Intelligence	2.330
276.	Mahalingam, Dr M Subramoniam	Mr.Mahalingam	Optimal Object Detection and Tracking in Occluded Video Using DNN and Gravitational Search Algorithm	05 Nov 2020/Vol 24	Soft Computing	3.643
277.	Dr.M.Subramoniam	Mr.Binson V A	Design and Development of an e-nose System for the Diagnosis of Pulmonary Disease	06.01.2021/Vol 23/Issue 1	Acta of Bioengineering and Biomechanics	1.073

278.	Megalan Leo L	Megalan Leo L	Learning compact and discriminative hybrid neural network for dental caries classification	05-01-2021	Microprocessors and Microsystems	1.525
279.	Anita Daniel. D	Emalda Roslin. S	Data validation and integrity verification for trust based data aggregation protocol in WSN	23 October 2020	Microprocessors and Microsystems	1.525
280.	Muthiah M.A Assistant Professor	Muthiah M.A	Performance Evaluation of Conventional CNN Architectures and Modified ALEXNET for the Classification of Potatoes by Thermal Imaging	23 November 2020/56	Russian Journal of Nondestructive Testing	0.692
281.	Gopi Krishna Durbhaka and Barani Selvaraj	Tanzila Saba	Swarm-LSTM: Condition Monitoring of Gearbox Fault Diagnosis based on Hybrid LSTM Deep Neural Network Optimized by Swarm Intelligence Algorithms	26 Nov 2020	Computers, Materials & Continua	3.772
282.	J. Adeline Sneha	Rekha Chakravarthi	Identification, behavior analysis, and control of snail pest in agricultural fields using signal analysis and nanoparticles	20 April 2021	Applied Nanoscience	3.674
283.	Aravind, A.R	Aravind, A.R	Fractional rider optimization algorithm for the optimal placement of the mobile sinks in wireless sensor networks	15.12.2020	International Journal of Communication Systems	2.047
284.	G JEGAN	T Samraj Lawrence	Synthesis, Mechanical, and Tribological Performance Analysis of Stir-Casted AA7079: ZrO <sub>2</sub> + Si <sub>3</sub> N <sub>4</sub> Hybrid Composites by Taguchi Route	19th june 2021, Vol.: 2021 article id:7722370	Advances in Materials Science and Engineering	1.726
285.	Jamuna Rani D	S Emalda Roslin	Optimized Implementation of Gift Cipher	07 March 2021	Wireless Personal Communications	1.671
286.	Varadala Sridhar, Research Scholar	S .EmaldaRoslin	Latency and Energy Efficient Bio Inspired Conic Optimized and Distributed Q Learning for D2D Communication in 5G	05 April 2021	IETE Journal of Research	2.333
287.	Sudheera, K.	N. M. Nandhitha	Deep Learning Techniques for Flaw Characterization in Weld Pieces from Ultrasonic Signals	21 December 2020, 56(10),	Russian Journal of Nondestructive Testing	0.692
288.	Dr.V.ANU, Reader	Dr.V.ANU	Chennai tobacco vendors compliance to India's cigarette and other tobacco products Act (COTPA) 2003-A descriptive evaluation	17 Oct 2020, 58 ( Issue 1)	Indian Journal of Cancer	1.224

*Sathyabama  
is Committed  
towards  
achieving the  
United Nations*

**SUSTAINABLE  
DEVELOPMENT  
GOALS**